

AN3501NFBP

Luminance, chroma and linear audio signal processing IC for VCR

■ Overview

The AN3501NFBP is a luminance, chroma signal processing IC for VCR (PAL and NTSC). It also integrates a playback equalizer and an NTSC playback circuit.

A normal audio signal recording/playback circuit is added so as to design a signal processing PCB in common for both a HiFi and a normal model, resulting in space saving of equipment.

This IC is a completely adjustment-free device which has been realized by introducing an adjustment-free technology such as a Zener zap, and contributes to a more efficient design/development and production of an equipment.

■ Features

- Supply voltage range 4.8 V to 5.2 V (600 mW typ.)
 - Usable for 4.43 MHz/3.58 MHz systems
 - 4.43 MHz system: PAL/NTSC/ME-SECAM
 - 3.58 MHz system: NTSC/PAL-N
- Adjustment-free
 - Video output level (recording mode)
 - Video output level (playback mode)
 - White clip level
 - f_0 frequency: sync. tip frequency
 - FM deviation
 - FM level (recording mode)
 - Chroma level (recording mode)
- Normal audio circuit built in
- NTSC to PAL conversion by adopting a simplified NTSC playback circuit of a line skip method.
- ME-SECAM discrimination circuit built-in
- All filters built-in, including a CCD filter
- The upper part flicker suppression by adoption of an ACC circuit by the field and an adaptive APC circuit

■ Applications

- VCR, camera recorder, combined CTV/VCR set

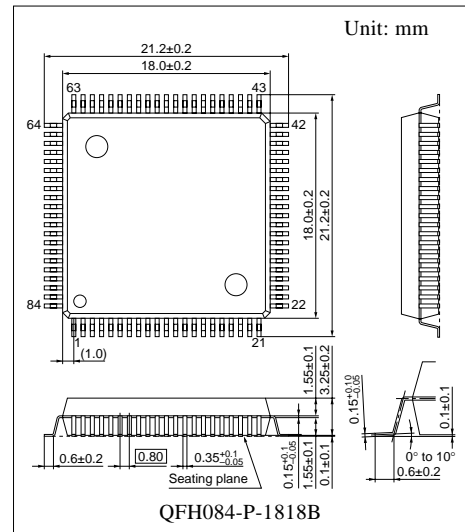

■ Block Diagram

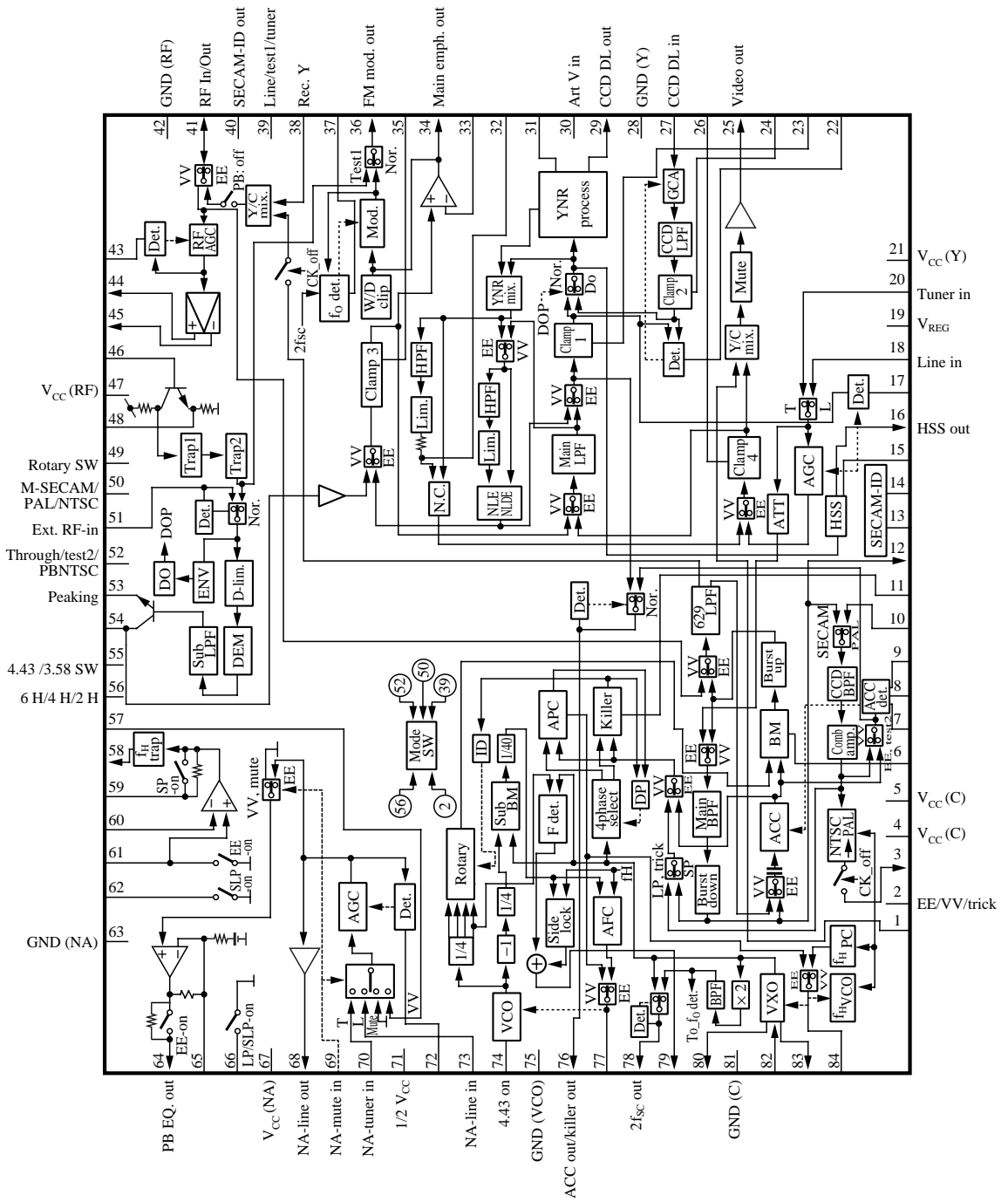

■ Pin Descriptions

Pin No.	Description	Pin No.	Description
1	Y/C mix. chroma input pin	38	Rec. Y-mix. in
2	EE/VV/trick changeover	39	Line/test1/tuner changeover
3	PB chroma output	40	SECAM-ID out
4	Chroma $V_{CC(1)}$	41	RF In/Out
5	Chroma $V_{CC(2)}$	42	RF GND
6	BM DC det.	43	RF AGC det./EE edit high
7	ACC det.	44	Phase shift pos.
8	F. ACC det. (ROT: high)	45	Phase shift neg.
9	F. ACC det. (ROT: low)	46	Phase shift in
10	C comb filter input	47	RF V_{CC}
11	Killer det.	48	RF EQ. peaking/SQPB high
12	C comb filter output	49	Rotary in
13	SECAM det. 1	50	M-SECAM/PAL/NTSC changeover
14	SECAM det. 2	51	Ext. RF in
15	Sync. sepa. det.	52	Through/test2/PBNTSC changeover
16	HSS out	53	Peaking
17	AGC det.	54	Main de-emphasis
18	Line in	55	4.43 MHz/3.58 MHz changeover
19	V_{REG} (2.0 V)	56	SLP/LP/SP changeover
20	Tuner in	57	NA-PB amp. in
21	Lumi. V_{CC}	58	NA-PB EQ. out
22	CCD AGC det.	59	NA-PB EQ. SW
23	Sub clamp det. 1	60	NA-PB NF
24	Sub clamp det. 2	61	NA-PB in
25	Video out	62	NA-PB in EQ./SLP
26	Sub clamp det. 4	63	NA GND
27	CCD DL in	64	NA-rec. out
28	Lumi. GND	65	NA-rec. EQ. NF
29	CCD DL out	66	NA-rec. EQ. LP/SLP
30	Quasi-sync. pulse input	67	NA V_{CC}
31	YNR lim. DC	68	NA-line out
32	N.C. LPF	69	NA-mute in
33	Main emph. FB in/VV edit high	70	NA-tuner in
34	Main emph. out	71	1/2 V_{CC}
35	Sub clamp det. 3	72	NA-AGC det.
36	FM mod. out	73	NA-line in
37	f_O det.	74	VCO f_O

■ Pin Descriptions (continued)

Pin No.	Description	Pin No.	Description
75	VCO GND	80	XO/VCXO out
76	ACC out/killer out	81	C GND
77	Rec. AFC/PB APC det.	82	XO/VCXO in
78	2f _{SC} out	83	XO/VCXO out
79	Side lock det.	84	Rec. APC/f _H AFC det.

■ Absolute Maximum Ratings

Parameter	Symbol	Rating	Unit
Supply voltage	V _{CC}	5.5	V
Supply current	I _{CC}	175	mA
Power dissipation *2	P _D	660	mW
Operating ambient temperature *1	T _{opr}	-20 to +70	°C
Storage temperature *1	T _{stg}	-25 to +125	°C

Note) 1. *1: Except for the operating ambient temperature and storage temperature, all ratings are for T_a = 25°C.

*2: The power dissipation shown is for the IC package at T_a = 70°C

■ Recommended Operating Range

Parameter	Symbol	Range	Unit
Supply voltage	V _{CC}	4.8 to 5.2	V

■ Electrical Characteristics at V_{CC} = 5 V, T_a = 25°C

Parameter	Symbol	Conditions	Min	Typ	Max	Unit
DC characteristics						
Supply current (EE)	I _{CCR}	V _{CC} = 5 V, EE mode	92	117	144	mA
Supply current (VV)	I _{CCP}	V _{CC} = 5 V, VV mode	105	133	164	mA
High mode hold voltage	V _H	Pin 2, pin 39, pin 50, pin 52, pin 56	3.5	—	5.0	V
Middle mode hold voltage	V _M	Pin 2, pin 39, pin 50, pin 52, pin 56	1.75	—	3.0	V
Low mode hold voltage	V _L	Pin 2, pin 39, pin 50, pin 52, pin 56	0	—	1.25	V
Sync. level insertion mode hold voltage	V _{30H}		3.5	—	5.0	V
Gray level insertion mode hold voltage	V _{30M}		1.5	—	3.0	V
Through mode hold voltage	V _{30L}		0	—	1.0	V
Rotary SWH hold voltage	V _{49H}		3.5	—	5.0	V
Rotary SWL hold voltage	V _{49L}		0	—	1.25	V
4.43 MHz mode hold voltage	V _{55H}		1.75	—	5.0	V
3.58 MHz mode hold voltage	V _{55L}		0	—	1.25	V

■ Electrical Characteristics at $V_{CC} = 5\text{ V}$, $T_a = 25^\circ\text{C}$ (continued)

Parameter	Symbol	Conditions	Min	Typ	Max	Unit
DC characteristics (continued)						
Audio mute hold voltage	V_{69H}		3.5	—	5.0	V
Audio through hold voltage	V_{69L}		0	—	1.25	V
After-recording mode hold voltage	V_{70H}		4.0	—	5.0	V
Insertion mode hold voltage	V_{70L}		0	—	1.0	V
VV edit mode hold voltage	V_{33H}		4.0	—	5.0	V
EE edit mode hold voltage	V_{43H}		4.0	—	5.0	V
SQPB mode hold voltage	V_{48H}		3.25	—	5.0	V
Luminance recording system						
AGC characteristics	ΔV_{18-25}	White 100%, $V_{IN} = [2.0\text{ V[p-p]}/[0.5\text{ V[p-p]}]]$	-0.5	0.5	1.0	dB
EE out amplitude (PAL)	V_{20-25P}	White 100%, V: S = 7: 3, $V_{IN} = 1\text{ V[p-p]}$	1.995	2.1	2.205	V[p-p]
AGC frequency characteristics	f_{20-25}	$f_{IN} = 5\text{ MHz}/1\text{ MHz}$	-2.0	-0.5	0.5	dB
AGC output level ratio	ΔV_{20-25}	White 140%, 1.28 V[p-p], Ratio to V_{20-25P}	0.05	0.55	1.25	dB
EE out amplitude (NTSC)	V_{20-25N}	White 100%, $V = 0.714\text{ V[p-p]}$, $V_{IN} = 1\text{ V[p-p]}$	1.9	2.1	2.3	V[p-p]
M LPF frequency characteristics 1	$f_{18-76(1)}$	4.43 MHz mode, $V_{IN} = 100\text{ mV[p-p]}$ $f_{IN} = 2\text{ MHz}/0.15\text{ MHz}$	-1.7	0.1	0.9	dB
M LPF frequency characteristics 2	$f_{18-76(2)}$	4.43 MHz mode, $V_{IN} = 100\text{ mV[p-p]}$ $f_{IN} = 3\text{ MHz}/0.15\text{ MHz}$	-4.2	-2.2	-0.7	dB
M LPF frequency characteristics 3	$f_{18-76(3)}$	4.43 MHz mode, $V_{IN} = 100\text{ mV[p-p]}$ $f_{IN} = 4.43\text{ MHz}/0.15\text{ MHz}$	—	-35	-30	dB
M LPF frequency characteristics 4	$f_{18-76(4)}$	3.58 MHz mode, $V_{IN} = 100\text{ mV[p-p]}$ $f_{IN} = 2.2\text{ MHz}/0.15\text{ MHz}$	-4.8	-1.8	0.2	dB
M LPF frequency characteristics 5	$f_{18-76(5)}$	3.58 MHz mode, $V_{IN} = 100\text{ mV[p-p]}$ $f_{IN} = 3.58\text{ MHz}/0.15\text{ MHz}$	—	-39	-27	dB
Sync. separation minimum input sensitivity	S_{16}	White 100%, $V_{IN} = 0.145\text{ V[p-p]}$, Pin 76 amplitude	23	30	37	%
Sync. separation output pulse front-edge delay	T_{16}	White 100%, $V_{IN} = 1.0\text{ V[p-p]}$, including LPF	1.14	1.34	1.54	μs
Sync. separation low-level output pulse	V_{16L}	$R_L (V_{CC}) = 10\text{ k}\Omega$	—	—	0.7	V
Sync. separation high-level output pulse	V_{16H}	$R_L (\text{GND}) = 22\text{ k}\Omega$	4.5	—	—	V
Vertical emph. 1-K value gain 1	$G_{76-29(1)}$	$V_{76} = 400\text{ mV[p-p]}$, LP, $f_{IN} = 150\text{ kHz}$	-3.0	-1.5	0	dB
Vertical emph. 1-K value gain 2	$G_{76-29(2)}$	$V_{76} = 400\text{ mV[p-p]}$, LP, $f_{IN} = 2\text{ MHz}$	-1.5	0	1.5	dB
Vertical emph. difference signal amplitude	ΔV_{VE}	White 100%, 1 V[p-p]	—	30	100	mV[p-p]

■ Electrical Characteristics at $V_{CC} = 5\text{ V}$, $T_a = 25^\circ\text{C}$ (continued)

Parameter	Symbol	Conditions	Min	Typ	Max	Unit
Luminance recording system (continued)						
Vertical emph. X value gain	G_{31-33}	$V_{IN} = 40\text{ mV[p-p]}$, $f_{IN} = 150\text{ kHz}$	-18.5	-15.0	-11.5	dB
CCD input output level	V_{29}	$V_{IN} = 1\text{ V[p-p]}$, white 100%	375	405	440	mV[p-p]
NL emphasis/detail enhancer frequency characteristics 1	$G_{NE(1)}$	SP/edit: $V_{76} = -20\text{ dB}$, $f_{IN} = 500\text{ kHz}/150\text{ kHz}$	0.4	1.2	2.0	dB
NL emphasis/detail enhancer frequency characteristics 2	$G_{NE(2)}$	SP/edit: $V_{76} = -20\text{ dB}$, $f_{IN} = 2\text{ MHz}/150\text{ kHz}$	1.7	2.9	4.1	dB
NL emphasis/detail enhancer frequency characteristics 3	$G_{NE(3)}$	SP/normal: $V_{76} = -20\text{ dB}$, $f_{IN} = 500\text{ kHz}/150\text{ kHz}$	1.1	2.1	3.1	dB
NL emphasis/detail enhancer frequency characteristics 4	$G_{NE(4)}$	SP/normal: $V_{76} = -20\text{ dB}$, $f_{IN} = 2\text{ MHz}/150\text{ kHz}$	3.2	4.7	6.2	dB
NL emphasis/detail enhancer frequency characteristics 5	$G_{NE(5)}$	LP: $V_{76} = -20\text{ dB}$, $f_{IN} = 500\text{ kHz}/150\text{ kHz}$	2.54	3.84	5.14	dB
NL emphasis/detail enhancer frequency characteristics 6	$G_{NE(6)}$	LP: $V_{76} = -20\text{ dB}$, $f_{IN} = 2\text{ MHz}/150\text{ kHz}$	3.9	5.9	7.9	dB
NL emphasis/detail enhancer frequency characteristics 7	$G_{NE(7)}$	LP: $V_{76} = 0\text{ dB}$, $f_{IN} = 2\text{ MHz}/150\text{ kHz}$	0.2	0.9	1.6	dB
Main emphasis gain	G_{ME}	$1\text{ k}\Omega/220+0.1\text{ }\mu\text{F}$, $f_{IN} = 150\text{ kHz}$	13	15	17	dB
Main emphasis standard output level	V_{ME}	White 100%, 1 V[p-p]	350	400	450	mV[p-p]
White clip level	LV_{WC}	White 100%	176	183	190	%
Dark clip level	LV_{DC}	White 100%	43	55	65	%
FM mod. output frequency (4.43 PAL)	f_{36P}	No input 4.43 MHz mode, PAL mode	3.75	3.81	3.85	MHz
FM mod. output frequency (4.43 NTSC)	$f_{36N(1)}$	No input 4.43 MHz mode, NTSC mode	3.37	3.47	3.57	MHz
FM mod. output frequency (3.58 NTSC)	$f_{36N(2)}$	No input 3.58 MHz mode, NTSC mode	3.29	3.39	3.49	MHz
FM mod. output secondary distortion (PAL)	$2f_{36P}$	No input PAL mode	—	-45	-35	dB
FM mod. deviation (PAL)	D_{36P}	White 100%	0.95	1.0	1.05	MHz
FM mod. deviation (NTSC)	D_{36N}	White 100%	0.9	1.0	1.1	MHz
Rec. FM total output amplitude (PAL)	V_{FM}	$V_{36}/4 \times G_{38-41}$, V_{36} : pin 36 amplitude	332.5	350	367.5	mV[p-p]
Rec. FM amp. frequency characteristics	f_{38-41}	10 MHz/4 MHz	-2.5	-0.5	0.5	dB
Luminance playback system						
FM demodulation sensitivity (VHS)	ΔV_{53V}	Pin 51 input, $f_{IN} = 3.8\text{ MHz}$, 4.8 MHz	0.13	0.175	0.22	V/MHz
FM demodulation sensitivity (SQPB)	ΔV_{53S}	Pin 51 input, $f_{IN} = 5.4\text{ MHz}$, 7.0 MHz	0.13	0.175	0.22	V/MHz

■ Electrical Characteristics at $V_{CC} = 5\text{ V}$, $T_a = 25^\circ\text{C}$ (continued)

Parameter	Symbol	Conditions	Min	Typ	Max	Unit
Luminance playback system (continued)						
PB output amplitude	V_{PB}	Pin 51 input, $f_{IN} = 3.8\text{ MHz}$, 4.8 MHz	1.995	2.1	2.205	V[p-p]
Drop out detect SW on level	S_{51}	$f_{IN} = 4\text{ MHz}$, $0\text{ dB} = 350\text{ mV[p-p]}$	-22	-18	-14	dB
Drop out detect hysteresis	ΔS_{51}	$f_{IN} = 4\text{ MHz}$, $0\text{ dB} = 350\text{ mV[p-p]}$	1.0	3.0	5.0	dB
Env. detect SW operating time	T_{ENV}	AM wave 1 kHz , $V_{IN} = 350\text{ mV}$, $f_{IN} = 4\text{ MHz}$	180	224	270	μs
NL de-emphasis frequency characteristics 1	$G_{ND(1)}$	SP: $V_{IN} = -20\text{ dB}$, $f_{IN} = 500\text{ kHz}/150\text{ kHz}$	-2.7	-1.7	-0.7	dB
NL de-emphasis frequency characteristics 2	$G_{ND(2)}$	SP: $V_{IN} = -20\text{ dB}$, $2\text{ MHz}/150\text{ kHz}$	-5.5	-4.2	-3.0	dB
NL de-emphasis frequency characteristics 3	$G_{ND(3)}$	LP: $V_{IN} = -20\text{ dB}$, $f_{IN} = 500\text{ kHz}/150\text{ kHz}$	-6.2	-3.9	-2.2	dB
NL de-emphasis frequency characteristics 4	$G_{ND(4)}$	LP: $V_{IN} = -20\text{ dB}$, $2\text{ MHz}/150\text{ kHz}$	-9.0	-7.5	-6.2	dB
NL de-emphasis frequency characteristics 5	$G_{ND(5)}$	LP: $V_{IN} = 0\text{ dB}$, $2\text{ MHz}/150\text{ kHz}$	-2.7	-2.0	-1.3	dB
YNR 1-K value gain EDNC	G_{54-29E}	White 100% , $V_{IN} = 160\text{ mV[p-p]}$	4.5	6.0	7.5	dB
YNR 1-K value gain VNC	G_{54-29V}	White 100% , $V_{IN} = 160\text{ mV[p-p]}$	1.8	3.3	4.8	dB
YNR difference element amplitude EDNC	ΔV_{EDNC}	Rectangular wave, $V_{IN} = 160\text{ mV[p-p]}$	—	30	100	mV[p-p]
YNR difference element amplitude VNC	ΔV_{VNC}	Rectangular wave, $V_{IN} = 160\text{ mV[p-p]}$	—	10	100	mV[p-p]
YNR X value gain EDNC	G_{31-25E}	$V_{IN} = 40\text{ mV[p-p]}$, $f_{IN} = 150\text{ kHz}$	-4.9	-2.9	-1.3	dB
YNR X value gain VNC	G_{31-25V}	$V_{IN} = 40\text{ mV[p-p]}$, $f_{IN} = 150\text{ kHz}$	0.6	2.1	3.6	dB
YNR lim. (VNC) output level 1	$V_{25YL(1)}$	$V_{IN} = 800\text{ mV[p-p]}$, $f_{IN} = 150\text{ kHz}$	26	40	53	mV[p-p]
YNR lim. (VNC) output level 2	$V_{25YL(2)}$	$V_{IN} = 300\text{ mV[p-p]}$, $f_{IN} = 150\text{ kHz}$	13.5	25.0	37.0	mV[p-p]
YNR lim. (VNC) output level 3	$V_{25YL(3)}$	$V_{IN} = 100\text{ mV[p-p]}$, $f_{IN} = 150\text{ kHz}$	80	110	140	mV[p-p]
CCD AGC cover range	ΔV_{31}	$V_{54} = 160\text{ mV[p-p]}$, rectangular wave, CCD Gain $\pm 3\text{ dB}$	0	30	100	mV[p-p]
Noise canceller frequency characteristics 1	$G_{25N(1)}$	Normal mode, $V_{27} = -30\text{ dB}$, Including CCD LPF, $f_{IN} = 1\text{ MHz}/150\text{ kHz}$	-13.0	-8.0	-4.8	dB
Noise canceller frequency characteristics 2	$G_{25N(2)}$	Normal mode, $V_{27} = -30\text{ dB}$, Including CCD LPF, $f_{IN} = 2\text{ MHz}/150\text{ kHz}$	-9.3	-4.5	-2.3	dB
Noise canceller frequency characteristics 3	$G_{25N(3)}$	Normal mode, $V_{27} = 0\text{ dB}$, Including CCD LPF, $f_{IN} = 2\text{ MHz}/150\text{ kHz}$	-0.8	1.2	2.7	dB
Noise canceller frequency characteristics 4	$G_{25N(4)}$	Edit mode, $V_{27} = -30\text{ dB}$, Including CCD LPF, $f_{IN} = 2\text{ MHz}/150\text{ kHz}$	-0.3	-1.0	0.5	dB
Video output sync. DC level	ΔV_{SYNC}	White 100% , $V_{27} = 317\text{ mV[p-p]}$	0.8	0.95	1.1	V
Video output quasi-V offset voltage	ΔV_{25A}	$V_{30} = 5\text{ V}$	-30	0	60	mV
Video output quasi-H offset voltage	ΔV_{25G}	$V_{30} = 2.5\text{ V}$	0.85	1.0	1.15	V

■ Electrical Characteristics at $V_{CC} = 5\text{ V}$, $T_a = 25^\circ\text{C}$ (continued)

Parameter	Symbol	Conditions	Min	Typ	Max	Unit
Luminance playback system (continued)						
Chroma mix. output gain	G_{1-25}	$V_{IN} = 600\text{ mV[p-p]}$, $f_{IN} = 5\text{ MHz}$	4.9	6.6	8.3	dB
Chroma mix. frequency characteristics	f_{1-25}	$V_{IN} = 600\text{ mV[p-p]}$, $f_{IN} = 5\text{ MHz/1 MHz}$	-0.5	0.3	1.0	dB
RF-AGC output amplitude	V_{41-45}	$V_{IN} = 200\text{ mV[p-p]}$, $f = 4\text{ MHz}$	170	215	265	mV[p-p]
RF-AGC sensitivity	S_{RF}	$\pm 6\text{ dB input}$	—	0.5	3.0	dB
RF-AGC output distortion	D_{RF}	$V_{IN} = 400\text{ mV[p-p]}$, $f = 4\text{ MHz}$	—	-44	-35	dB
RF-AGC maximum gain	G_{RFAGC}	$V_{IN} = 20\text{ mV[p-p]}$, $f = 4\text{ MHz}$	8.5	10.5	12.5	dB
RF-EQ. frequency characteristics 2	GEQ2	$V_{IN} = 20\text{ mV[p-p]}$, $f = 1\text{ MHz/5 MHz}$	-24.0	-15.0	-9.0	dB
RF-EQ. frequency characteristics 3	GEQ3	$f = 2\text{ MHz/5 MHz}$	-9.8	-5.3	-3.3	dB
RF-EQ. frequency characteristics 4	GEQ4	$f = 630\text{ kHz/5 MHz}$	—	-30	-15	dB
RF-EQ. frequency characteristics 5	GEQ5	$f = 8\text{ MHz/5 MHz}$	—	-30	-15	dB
RF-EQ. total characteristics	V_{41-36}	$V_{IN} = 200\text{ mV[p-p]}$	305	435	605	mV[p-p]
Chroma recording system						
Output DC for color	V_{76CO}	Color, $V_{I1} = 3.5\text{ V}$	3.5	—	—	V
Output DC for killer	V_{76CK}	Killer, $V_{I1} = 1.5\text{ V}$	—	—	0.5	V
Burst up gain	G_{BUP}	$V_{IN} = 1: 1$ ($B = 300\text{ mV[p-p]}$)	5	6	7	dB
Rec. APC pull in range 1	$f_{APC(1)}$	4.43 MHz mode, $f_{IN} = f_{SC} + 500\text{ Hz}$	500	800	—	Hz
Rec. APC pull in range 2	$f_{APC(2)}$	4.43 MHz mode, $f_{IN} = f_{SC} - 500\text{ Hz}$	—	-800	-500	Hz
Rec. APC pull in range 3	$f_{APC(3)}$	3.58 MHz mode, $f_{IN} = f_{SC} + 500\text{ Hz}$	500	800	—	Hz
Rec. APC pull in range 4	$f_{APC(4)}$	3.58 MHz mode, $f_{IN} = f_{SC} - 500\text{ Hz}$	—	-800	-500	Hz
VXO free-run frequency 1	$f_{VXO(1)}$	4.43 MHz mode, SECAM mode	-100	0	100	Hz
VXO free-run frequency 2	$f_{VXO(2)}$	3.58 MHz mode, SECAM mode	-100	0	100	Hz
Rec. chroma output amplitude	V_{CR}	B: C = 1: 2 chroma level	75.6	82	88.4	mV[p-p]
ACC characteristics 1	ΔV_{ACC1}	$V_{IN} = 1: 1$, +9, -5 dB, $V_{49} = 5\text{ V}$	—	—	3	dB
ACC characteristics 2	ΔV_{ACC2}	$V_{IN} = 1: 1$, +9, -5 dB, $V_{49} = 0\text{ V}$	—	—	3	dB
630k LPF frequency characteristics 1	$f_{RL(1)}$	4.43 MHz mode, $V_{IN} = 200\text{ mV[p-p]}$, 150 kHz/630 kHz	-0.7	0.3	1.3	dB
630k LPF frequency characteristics 2	$f_{RL(2)}$	4.43 MHz mode, $V_{IN} = 200\text{ mV[p-p]}$, 3 MHz/630 kHz	—	-25	-15	dB
630k LPF frequency characteristics 3	$f_{RL(3)}$	4.43 MHz mode, $V_{IN} = 200\text{ mV[p-p]}$, 4.43 MHz/630 kHz	—	-35	-20	dB
630k LPF group delay	GD_{RL}	4.43 MHz mode, $V_{IN} = 200\text{ mV[p-p]}$, $f_{IN} = 630\text{ kHz}$	310	360	410	ns
630k LPF frequency characteristics 4	$f_{RL(4)}$	3.58 MHz mode, $V_{IN} = 200\text{ mV[p-p]}$, 2 MHz/630 kHz	-2.0	0	2.0	dB
SECAM discrimination output DC 1	$V_{40(1)}$	4.43 MHz mode, PAL mode, $f_{IN} = 4.43\text{ MHz}$	0	—	0.65	V
SECAM discrimination output DC 2	$V_{40(2)}$	4.43 MHz mode, SECAM mode, $f_{IN} = 4.25\text{ MHz}, 4.41\text{ MHz}$	4	—	5	V

■ Electrical Characteristics at $V_{CC} = 5\text{ V}$, $T_a = 25^\circ\text{C}$ (continued)

Parameter	Symbol	Conditions	Min	Typ	Max	Unit
Chroma playback system						
Comb amp. gain SP	G_{MB}	SP mode, $f_{SC} = 4.43\text{ MHz}$	1.3	3.3	5.3	dB
Comb amp. gain LP	ΔG_{MB}	Difference from EP mode and SP mode	0.6	1.6	2.6	dB
Burst down gain 1	$G_{BD(1)}$	$V_{IN} = 1: 1$ ($B = 440\text{ mV[p-p]}$), NTSC/SP mode	-6.2	-5.2	-4.2	dB
Main BM carrier leak	G_{CL}	$V_{IN} = 250\text{ mV[p-p]}$, $f_{IN} = 630\text{ kHz}$ without signal	—	-45	-38	dB
Main BM signal leak	G_{SL}	$V_{IN} = 250\text{ mV[p-p]}$, $f_{IN} = 630\text{ kHz}$	—	-55	-38	dB
XO free-run frequency 1	$f_{XO(1)}$	4.43 MHz mode, $1/2 \times f_{78}$	-50	—	50	Hz
XO free-run frequency 2	$f_{XO(2)}$	3.58 MHz mode, $1/2 \times f_{78}$	-50	—	50	Hz
$2f_{SC}$ output level 1	$V_{2fsc(1)}$	4.43 MHz mode	240	370	500	mV[p-p]
$2f_{SC}$ output level 2	$V_{2fsc(2)}$	3.58 MHz mode	260	400	540	mV[p-p]
f_{SC} output level 1	$V_{fsc(1)}$	4.43 MHz mode	300	370	500	mV[p-p]
f_{SC} output level 2	$V_{fsc(2)}$	3.58 MHz mode	300	420	560	mV[p-p]
630 k BPF gain 1	$G_{PB(1)}$	4.43 MHz mode, $V_{IN} = 10\text{ mV[p-p]}$, $f_{IN} = 630\text{ kHz}$	25	30	35	dB
630k BPF frequency characteristics 1	$f_{PB(1)}$	4.43 MHz mode, $V_{IN} = 10\text{ mV[p-p]}$, $f_{IN} = 150\text{ kHz}/630\text{ kHz}$	-5.0	-2.0	-0.5	dB
630k BPF frequency characteristics 2	$f_{PB(2)}$	4.43 MHz mode, $V_{IN} = 10\text{ mV[p-p]}$, $f_{IN} = 930\text{ kHz}/630\text{ kHz}$	-4	-2.0	-0.5	dB
630k BPF frequency characteristics 3	$f_{PB(3)}$	4.43 MHz mode, $V_{IN} = 10\text{ mV[p-p]}$, $f_{IN} = 2.4\text{ MHz}/630\text{ kHz}$	—	-40	-30	dB
630k BPF gain 2	$G_{PB(2)}$	3.58 MHz mode, $f_{IN} = 630\text{ kHz}$, Difference from 4.43 MHz mode	-1.0	0	1.0	dB
630k BPF frequency characteristics 4	$f_{PB(4)}$	3.58 MHz mode, $f_{IN} = 930\text{ kHz}$, Difference from 4.43 MHz mode	-2.0	0	2.0	dB
f_{HVCO} pull-in range	f_{VCOmax}	$f_{IN} = f_H + 500\text{ Hz}$	500	—	—	Hz
	f_{VCOmin}	$f_{IN} = f_H - 500\text{ Hz}$	—	—	-500	
SECAM discrimination output DC 3	$V_{40(3)}$	4.43 MHz mode, SECAM mode, $f_{IN} = 0.63\text{ MHz}$	0	—	0.65	V
SECAM discrimination output DC 4	$V_{40(4)}$	4.43 MHz mode, PAL mode, $f_{IN} = 0.63\text{ MHz}, 0.65\text{ MHz}$	0	—	0.65	V
SECAM discrimination output DC 5	$V_{40(5)}$	4.43 MHz mode, SECAM mode, $f_{IN} = 0.67\text{ MHz}, 0.81\text{ MHz}$	4	—	5	V
SECAM discrimination output DC 6	$V_{40(6)}$	4.43 MHz mode, PAL mode, $f_{IN} = 0.65\text{ MHz}, 0.81\text{ MHz}$	4	—	5	V
Audio-system						
Line out gain	V_{EL}	$f = 1\text{ kHz}$, EE, -29 dBV	22.4	23.6	24.8	dB
Rec. out level ratio at SP	V_{ER1}	$f = 1\text{ kHz}$, EE, -29 dBV, ratio to VEL	-0.2	0.8	1.8	dB
Rec. out level ratio at SLP	V_{ER2}	$f = 1\text{ kHz}$, EE, -29 dBV, ratio to SP	-0.2	0.3	0.8	dB

■ Electrical Characteristics at $T_a = 25^\circ\text{C}$ (continued)

Parameter	Symbol	Conditions	Min	Typ	Max	Unit
Audio-system (continued)						
Rec. out distortion at LP	T_{ER1}	$f = 1 \text{ kHz}$, EE, -29 dBV	—	0.3	1	%
Rec. out SN SLP	N_{ER2}	EE	—	-65	-59	dBV
AGC level ratio	V_{ELA}	$f = 1 \text{ kHz}$, -9 dBV	—	0.3	3	dB
Line out distortion	T_{EL}	$f = 1 \text{ kHz}$, -29 dBV	—	0.3	1	%
Rec. out max. level	V_{ERMAX}	$f = 1 \text{ kHz}$, amplitude for distortion = 1%	-0.5	—	—	dBV
PB gain SP	V_{VL1}	$f = 1 \text{ kHz}$, -68.3 dBV	61	62	63	dB
PB level ratio SLP	V_{VL2}	$f = 1 \text{ kHz}$, -70.8 dBV	—	2	—	dB
PB distortion SLP	T_{VL2}	$f = 1 \text{ kHz}$, -70.8 dBV	—	0.5	1	%
Noise referred to input: SP	N_{VL1}	No input signal, $R_g = 1.5 \text{ k}\Omega$	—	—	1.8	$\mu\text{V[rms]}$
f_H attenuation	V_{TR1}	$f = 15.625 \text{ kHz}$	—	-15	-5	dB
Line out max. level	V_{LMAX}	$f = 1 \text{ kHz}$, amplitude for distortion = 1%	-1.5	—	—	dBV
Mute attenuation	V_{ML}	$f = 1 \text{ kHz}$, PB mode	—	—	-80	dB

• Design reference data

Note) The characteristics listed below are theoretical values based on the IC design and are not guaranteed.

Parameter	Symbol	Conditions	Min	Typ	Max	Unit
Luminance-system						
M LPF group delay 1	GD(1)	4.43 MHz mode, rec., $f_{IN} = 0.15 \text{ MHz}$	655	705	755	ns
M LPF group delay 2	GD(2)	3.58 MHz mode, rec., $f_{IN} = 0.15 \text{ MHz}$	670	750	830	ns
M LPF group delay difference	ΔGD	4.43 MHz mode, PB, $f_{IN} = 1 \text{ MHz}$, SQPB/VHS mode difference	155	180	225	ns
CCD LPF frequency characteristics 1	$G_{27-29(1)}$	4.43 MHz mode, EDNC, $V_{IN} = 312 \text{ mV[p-p]}$, $f_{IN} = 3 \text{ MHz}/0.2 \text{ MHz}$	-2.0	0.5	1.5	dB
CCD LPF frequency characteristics 2	$G_{27-29(2)}$	4.43 MHz mode, EDNC, $V_{IN} = 312 \text{ mV[p-p]}$, $f_{IN} = 13.3 \text{ MHz}/0.2 \text{ MHz}$	—	-30	-25	dB
CCD LPF group delay 1	$\text{GD}_{29(1)}$	4.43 MHz mode, EDNC, $V_{IN} = 312 \text{ mV[p-p]}$, $f_{IN} = 0.2 \text{ MHz}$	90	120	150	ns
CCD LPF frequency characteristics 3	$G_{27-29(3)}$	3.58 MHz mode, EDNC, $V_{IN} = 312 \text{ mV[p-p]}$, $f_{IN} = 2 \text{ MHz}/0.2 \text{ MHz}$	-3.0	0.7	2.0	dB
CCD LPF frequency characteristics 4	$G_{27-29(4)}$	3.58 MHz mode, EDNC, $V_{IN} = 312 \text{ mV[p-p]}$, $f_{IN} = 7.2 \text{ MHz}/0.2 \text{ MHz}$	—	-2.5	-20	dB
CCD LPF group delay 2	$\text{GD}_{29(2)}$	3.58 MHz mode, EDNC, $V_{IN} = 312 \text{ mV[p-p]}$, $f_{IN} = 0.2 \text{ MHz}$	85	125	165	ns
FM carrier interleave	CI_{36}	EP mode, V_{37} : fixed	6.4	7.9	9.4	kHz
FM demod min. input level	$V_{51\text{MIN}}$	$f_{IN} = 3.8 \text{ MHz}$, 4.8 MHz	10	—	—	mV[p-p]
FM demod linearity	$L_{53\text{V}}$	$f_{IN} = 3 \text{ MHz}$, 4 MHz , 5 MHz	0.82	0.92	1.05	—
Sub LPF frequency characteristics 1	G_{SL1}	$f_{IN} = 2 \text{ MHz}/1.5 \text{ MHz}$, $f_{OUT} = 4 \text{ MHz}/3 \text{ MHz}$	-2.7	-0.5	1.0	dB
Sub LPF frequency characteristics 2	G_{SL2}	$f_{IN} = 3 \text{ MHz}/1.5 \text{ MHz}$, $f_{OUT} = 6 \text{ MHz}/3 \text{ MHz}$	-16.5	-12.0	-8.4	dB

■ Electrical Characteristics at $T_a = 25^\circ\text{C}$ (continued)

• Design reference data (continued)

Note) The characteristics listed below are theoretical values based on the IC design and are not guaranteed.

Parameter	Symbol	Conditions	Min	Typ	Max	Unit
Luminance-system (continued)						
DOC SW crosstalk	CT_{25-54}	$V_{IN} = 160 \text{ mV[p-p]}$, 1 MHz forced DOC	—	—	-40	dB
YNR lim. (VNC) output level 4	V_{25YL4}	$V_{IN} = 300 \text{ mV[p-p]}$, $f_{IN} = 1 \text{ MHz}$	15	30	45	mV[p-p]
White noise compression level	V_{25WNS}	Trick mode, 3.8 MHz, 5.8 MHz	2.2	2.9	3.3	V[p-p]
Tune/line crosstalk	CT_{20-18}	$f = 1 \text{ MHz}$	—	—	-40	dB
Line/tuner crosstalk	CT_{18-20}	$f = 1 \text{ MHz}$	—	—	-40	dB
Chroma-system						
M BPF [4.43 MHz] frequency characteristics rec. 1	$f_{MR(1)-4}$	4.43 MHz mode, $f_{IN} = 2.3 \text{ MHz}/4.43 \text{ MHz}$	—	—	-15	dB
M BPF [4.43 MHz] frequency characteristics rec. 2	$f_{MR(2)-4}$	4.43 MHz mode, $f_{IN} = 3.93 \text{ MHz}/4.43 \text{ MHz}$	-3.5	-2.0	-0.5	dB
M BPF [4.43 MHz] frequency characteristics rec. 3	$f_{MR(3)-4}$	4.43 MHz mode, $f_{IN} = 4.93 \text{ MHz}/4.43 \text{ MHz}$	-2.7	-1.2	0.6	dB
M BPF [4.43 MHz] frequency characteristics rec. 4	$f_{MR(4)-4}$	4.43 MHz mode, $f_{IN} = 6.5 \text{ MHz}/4.43 \text{ MHz}$	—	—	-10	dB
M BPF [4.43 MHz] group delay rec.	GD_{MR-4}	4.43 MHz mode, $f_{IN} = 4.43 \text{ MHz}$	340	390	440	ns
M BPF [4.43 MHz] frequency characteristics PB 1	$f_{MP(1)-4}$	4.43 MHz mode, $f_{IN} = 2.6 \text{ MHz}/4.43 \text{ MHz}$	—	—	-15	dB
M BPF [4.43 MHz] frequency characteristics PB 2	$f_{MP(2)-4}$	4.43 MHz mode, $f_{IN} = 3.93 \text{ MHz}/4.43 \text{ MHz}$	-5.5	-3.7	-2.0	dB
M BPF [4.43 MHz] frequency characteristics PB 3	$f_{MP(3)-4}$	4.43 MHz mode, $f_{IN} = 4.93 \text{ MHz}/4.43 \text{ MHz}$	-6.4	-3.9	-1.4	dB
M BPF [4.43 MHz] frequency characteristics PB 4	$f_{MP(4)-4}$	4.43 MHz mode, $f_{IN} = 5.69 \text{ MHz}/4.43 \text{ MHz}$	—	—	-30	dB
M BPF [4.43 MHz] frequency characteristics PB 5	$f_{MP(5)-4}$	4.43 MHz mode, $f_{IN} = 6.5 \text{ MHz}/4.43 \text{ MHz}$	—	—	-15	dB
M BPF [4.43 MHz] group delay PB	DG_{MP-4}	4.43 MHz mode, $f_{IN} = 4.43 \text{ MHz}$	530	580	630	ns
M BPF [3.58 MHz] frequency characteristics rec. 1	$f_{MR(1)-4}$	3.58 MHz mode, $f_{IN} = 1.5 \text{ MHz}/3.58 \text{ MHz}$	—	—	-15	dB
M BPF [3.58 MHz] frequency characteristics rec. 2	$f_{MR(2)-4}$	3.58 MHz mode, $f_{IN} = 3.08 \text{ MHz}/3.58 \text{ MHz}$	-5.5	-3.3	-15	dB
M BPF [3.58 MHz] frequency characteristics rec. 3	$f_{MR(3)-4}$	3.58 MHz mode, $f_{IN} = 4.08 \text{ MHz}/3.58 \text{ MHz}$	-3.5	-1.0	1.0	dB
M BPF [3.58 MHz] frequency characteristics rec. 4	$f_{MR(4)-4}$	3.58 MHz mode, $f_{IN} = 6.5 \text{ MHz}/3.58 \text{ MHz}$	—	—	-10	dB
M BPF [3.58 MHz] group delay rec.	GD_{MR-4}	3.58MHz mode, $f_{IN} = 3.58 \text{ MHz}$	390	470	550	ns











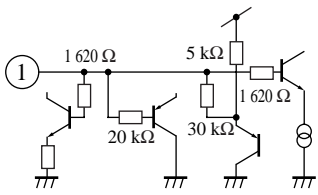

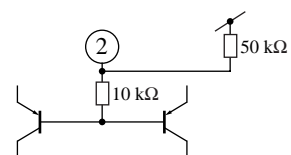
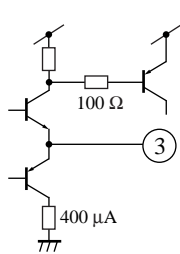
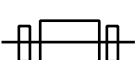
■ Electrical Characteristics at $T_a = 25^\circ\text{C}$ (continued)

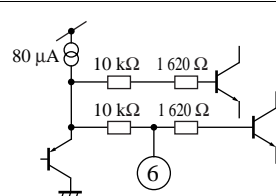
• Design reference data (continued)

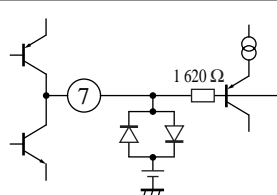
Note) The characteristics listed below are theoretical values based on the IC design and are not guaranteed.

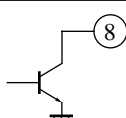
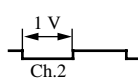
Parameter	Symbol	Conditions	Min	Typ	Max	Unit
Chroma-system (continued)						
M BPF [3.58 MHz] frequency characteristics PB 1	$f_{MP(1)-4}$	3.58 MHz mode, $f_{IN} = 1.5 \text{ MHz}/3.58 \text{ MHz}$	—	—	-15	dB
M BPF [3.58 MHz] frequency characteristics PB 2	$f_{MP(2)-4}$	3.58 MHz mode, $f_{IN} = 3.08 \text{ MHz}/3.58 \text{ MHz}$	-7.4	-4.8	-2.9	dB
M BPF [3.58 MHz] frequency characteristics PB 3	$f_{MP(3)-4}$	3.58 MHz mode, $f_{IN} = 4.08 \text{ MHz}/3.58 \text{ MHz}$	-7.2	-3.7	-1.2	dB
M BPF [3.58 MHz] frequency characteristics PB 4	$f_{MP(4)-4}$	3.58 MHz mode, $f_{IN} = 4.84 \text{ MHz}/3.58 \text{ MHz}$	—	—	-15	dB
M BPF [3.58 MHz] frequency characteristics PB 5	$f_{MP(5)-4}$	3.58 MHz mode, $f_{IN} = 6.5 \text{ MHz}/3.58 \text{ MHz}$	—	—	-10	dB
M BPF [3.58 MHz] group delay PB	GD_{MP-4}	3.58 MHz mode, $f_{IN} = 3.58 \text{ MHz}$	580	660	740	ns
CCD BPF frequency characteristics 1	$f_{CDB(1)}$	4.43 MHz mode, $V_{IN} = 300 \text{ mV[p-p]}$, $f_{IN} = 3.93 \text{ MHz}/4.43 \text{ MHz}$	-2.3	-0.3	0.7	dB
CCD BPF frequency characteristics 2	$f_{CDB(2)}$	4.43 MHz mode, $V_{IN} = 300 \text{ mV[p-p]}$, $f_{IN} = 4.93 \text{ MHz}/4.43 \text{ MHz}$	-2.2	0.1	0.8	dB
CCD BPF frequency characteristics 3	$f_{CDB(3)}$	4.43 MHz mode, $V_{IN} = 300 \text{ mV[p-p]}$, $f_{IN} = 8.86 \text{ MHz}/4.43 \text{ MHz}$	—	-38	-25	dB
CCD BPF frequency characteristics 4	$f_{CDB(4)}$	4.43 MHz mode, $V_{IN} = 300 \text{ mV[p-p]}$, $f_{IN} = 13.29 \text{ MHz}/4.43 \text{ MHz}$	—	-40	-30	dB
CCD BPF frequency characteristics 5	$f_{CDB(5)}$	3.58 MHz mode, $V_{IN} = 300 \text{ mV[p-p]}$, $f_{IN} = 3.08 \text{ MHz}/3.58 \text{ MHz}$	-3.2	-0.5	0.8	dB
CCD BPF frequency characteristics 6	$f_{CDB(6)}$	3.58 MHz mode, $V_{IN} = 300 \text{ mV[p-p]}$, $f_{IN} = 4.08 \text{ MHz}/3.58 \text{ MHz}$	-2.8	-0.2	1.2	dB
CCD BPF frequency characteristics 7	$f_{CDB(7)}$	3.58 MHz mode, $V_{IN} = 300 \text{ mV[p-p]}$, $f_{IN} = 7.16 \text{ MHz}/3.58 \text{ MHz}$	—	-32	-20	dB
CCD BPF frequency characteristics 8	$f_{CDB(8)}$	3.58 MHz mode, $V_{IN} = 300 \text{ mV[p-p]}$, $f_{IN} = 14.32 \text{ MHz}/3.58 \text{ MHz}$	—	-48	-30	dB
Phase shifter +45° gain	G_{HPF}	$V_{IN} = 300 \text{ mV[p-p]}$, $f_{IN} = 4.43 \text{ MHz}$	-7.0	-6.0	-5.0	dB
Phase shifter -45° gain	G_{LPF}	$V_{IN} = 300 \text{ mV[p-p]}$, $f_{IN} = 4.43 \text{ MHz}$	-7.0	-6.0	-5.0	dB
Phase shifter +45° phase	P_{HPF}	$V_{IN} = 300 \text{ mV[p-p]}$, $f_{IN} = 4.43 \text{ MHz}$	40	45	50	deg
Phase shifter -45° phase	P_{LPF}	$V_{IN} = 300 \text{ mV[p-p]}$, $f_{IN} = 4.43 \text{ MHz}$	-50	-45	-40	deg
VXO control sensitivity 1	$\beta_{VXO(1)}$	$V_{84} = 2.2 \text{ V}/2.6 \text{ V}$, $(1/2 \times \Delta f_{78}) / 400 \text{ mV}$	1.0	2.2	4.0	Hz/mV
VXO control sensitivity 2	$\beta_{VXO(2)}$	$V_{84} = 2.2 \text{ V}/2.6 \text{ V}$, $(1/2 \times \Delta f_{78}) / 400 \text{ mV}$	0.7	1.7	3.1	Hz/mV

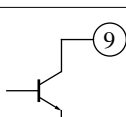







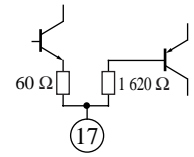
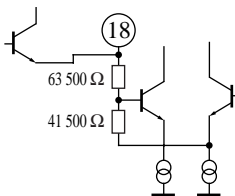

■ Terminal Equivalent Circuits

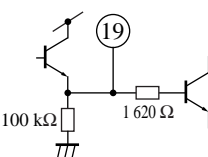
Pin No.	Equivalent circuit	Impe- dance (Z)	Description	Waveform		Voltage DC (V)
				EE mode	VV mode	
1		30 kΩ	Y/C mix. PB chroma input pin	—		4.5
2		50 kΩ	EE/VV/trick changeover pin	EE: 3.5 V to 5 V	VV: 1.75 V to 3.0 V Trick: 0 V to 1.25 V	—
3		EF	PB chroma output pin	—		2.0
4	—	—	V _{CC} pin (chroma main)	DC		5.0
5	—	—	V _{CC} pin (chroma APC)	DC		5.0
6		10 kΩ	BM balance capacitor pin	DC		2.7
7		High	ACC detection pin	DC		2.15
8		OC	Field AGC detection pin		 Note: off in trick mode	0.2 (on)
9		OC	Field AGC detection pin		 Note: off in trick mode	0.2 (on)

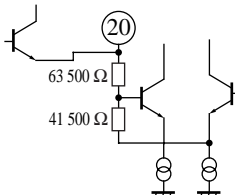

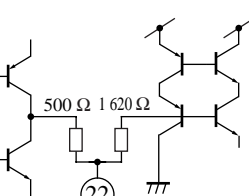

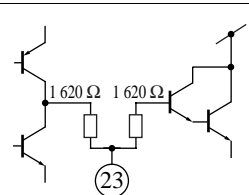





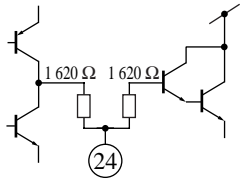

■ Terminal Equivalent Circuits (continued)

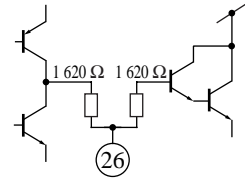
Pin No.	Equivalent circuit	Impedance (Z)	Description	Waveform		Voltage DC (V)
				EE mode	VV mode	
10		50 kΩ	Comb-side chroma input pin	—		2.7
11		High	Color killer detection pin	Killer on at 2.13 V or below		2.4
12		EF	Comb filter driving output pin	—		2.0
13		EF	SECAM detection 1-pin	DC		—
14		EF	SECAM detection 2-pin	DC		—
15		500 Ω + VT/IE	Sync. separation det. pin	DC		1.4
16		Rc	Sync. separation pulse output pin			—

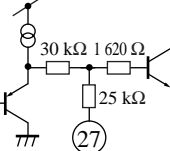

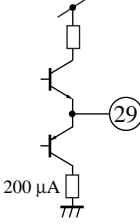

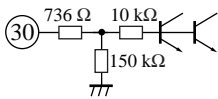
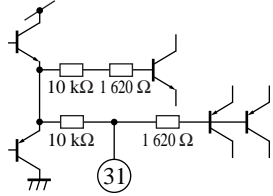
■ Terminal Equivalent Circuits (continued)

Pin No.	Equivalent circuit	Impe- dance (Z)	Description	Waveform		Voltage DC (V)
				EE mode	VV mode	
17		60 Ω + VT/IE	AGC detection pin	DC	—	2.25
18		105 kΩ	Line input pin		—	3.0
19		EF	V _{REG}	DC		2.0
20		105 kΩ	Tuner input pin		—	3.0
21	—	—	V _{CC} pin (Y-system)	DC		5.0
22		High	CCD AGC detection pin	DC		Typ. 2.4
23		High	Clamp 1 detection pin	DC		2.3



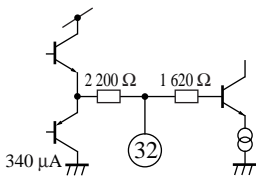
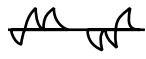
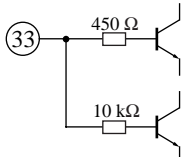

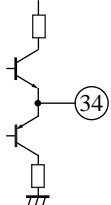
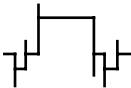
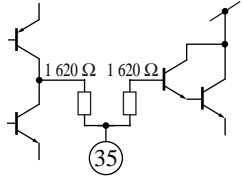

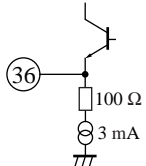
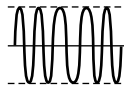
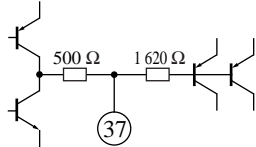
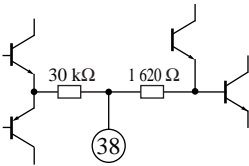
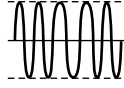
■ Terminal Equivalent Circuits (continued)

Pin No.	Equivalent circuit	Impe- dance (Z)	Description	Waveform		Voltage DC (V)
				EE mode	VV mode	
24		High	Clamp 2 detection pin	DC		2.3
25		EF	Video signal output pin			Sync. 1.0
26		High	Clamp 4 detection pin	DC		2.3
27		55 kΩ	CCD output pin			2.0
28	—	—	GND (Y-system)	—	—	0
29		EF	CCD input pin			Sync. 1.7
30		150 kΩ	Quasi sync. pulse input pin	—	Single level: 3.5 V to 5 V Gray level: 1.5 V to 3 V Through: 0 V to 1 V	—
31		10 kΩ	Correlation detection DC pin	DC		—

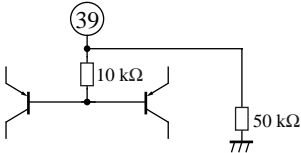
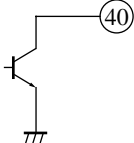
■ Terminal Equivalent Circuits (continued)

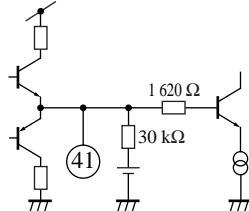
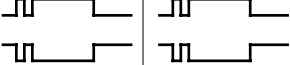
Pin No.	Equivalent circuit	Impe- dance (Z)	Description	Waveform		Voltage DC (V)
				EE mode	VV mode	
32		2.2 kΩ	N.C. LPF pin	—		2.4
33		OB	Main emphasis feedback input pin/ VV edit changeover pin		VV edit: 4 V to 5 V	Sync. 1.7
34		EF	Main emphasis output pin		—	Sync. 1.7
35		High	Clamp 3 detection pin	DC		2.3
36		EF	MOD output pin		—	2.5
37		High	f ₀ detection pin	DC	—	2.2
38		30 kΩ	Rec. FM input pin		—	2.7

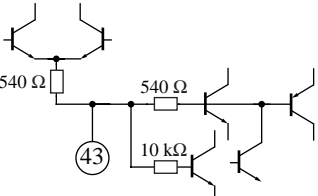
■ Terminal Equivalent Circuits (continued)

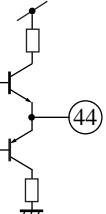
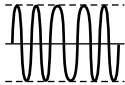
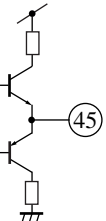
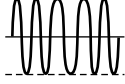
Pin No.	Equivalent circuit	Impe- dance (Z)	Description	Waveform		Voltage DC (V)
				EE mode	VV mode	
39		High	Line/test1/tuner changeover pin	Line: 3.5 V to 5 V Test1: 1.75 V to 3 V Tuner: 0 V to 1.25 V	Test1: 1.75 V to 3 V	—
40		Rc	SECAM ID output pin	DC High at SECAM		—
41		EF/ 30 kΩ	Rec. YC output pin/ PB envelope input pin			2.7
42	—	—	GND pin Y (PF-system)	DC	DC	0
43		540 Ω + EF	RF AGC detection pin/ EE edit changeover pin	EE edit: 4 V to 5 V		2.5
44		EF	Phase shift (positive)	DC	2.5	
45		EF	Phase shift (negative)	DC	2.5	

■ Terminal Equivalent Circuits (continued)

Pin No.	Equivalent circuit	Impe- dance (Z)	Description	Waveform		Voltage DC (V)
				EE mode	VV mode	
46		OB	Phase shift in	DC		2.5
47	—	—	V _{CC} pin Y (MOD output block RF system)	DC	DC	5.0
48		R _E	RF peaking/SQPB changeover pin	DC	 SQPB: 3.25 V to 5 V	1.0
49		OB	Rotary pulse input pin			—
50		50 kΩ	MESECAM/PAL/ NTSC changeover pin	MESECAM: 3.5 V to 5 V PAL: 1.75 V to 3 V NTSC: 0 V to 1.25 V		—
51		30 kΩ	Y ext. PF FM input pin	—	Pin 51: open Pin 51: 0 V to 1 V Internal RFEQ	3.0
52		High	PB NTSC changeover pin	PB NTSC: 3.5 V to 5 V Test2: 1.75 V to 3 V Through: 0 V to 1.25 V		—
53		VT/ IE	Main de-emphasis peaking pin	—		1.5

■ Terminal Equivalent Circuits (continued)

Pin No.	Equivalent circuit	Impe- dance (Z)	Description	Waveform		Voltage DC (V)
				EE mode	VV mode	
54		OC	Main de-emphasis output pin	—		3.5
55		High	4.43 MHz/3.58 MHz changeover pin	4.43: 1.75 V to 5 V 3.58: 0 V to 1.25 V		—
56		High	EP/LP/SP changeover pin	EP: 3.5 V to 5 V LP: 1.75 V to 3 V SP: 0 V to 1.25 V		—
57		32 kΩ	NA-PB amp. in	—		2.5
58		EF	NA-PB out	—		3.2
59		SP SLP 8 kΩ	NA-PB EQ. SW	—		2.5
60		O.B.	NA-PB NF	—		2.5

■ Terminal Equivalent Circuits (continued)

Pin No.	Equivalent circuit	Impe- dance (Z)	Description	Waveform		Voltage DC (V)
				EE mode	VV mode	
61		EE P.P. VV 80 kΩ	NA-PB in	DC	 -68.3 dBV	2.5
62		SP/LP 100 kΩ SLP	NA-PB SLP SW	DC		0
63	—	—	GND	—	—	0
64		EE P.P. VV 100 kΩ	NA-rec. out			2.5
65		1 kΩ	NA-rec. EQ. NF			2.5
66		SP 100 kΩ LP/ SLP P.P.	NA-rec. EQ. LP/ SLP SW	DC		2.5
67	—	—	V _{CC}	DC		5.0
68		P.P.	NA-line out		 (Typ.) -5.7 dBV = 1.47 V[p-p]	2.5

■ Terminal Equivalent Circuits (continued)

Pin No.	Equivalent circuit	Impe- dance (Z)	Description	Waveform		Voltage DC (V)
				EE mode	VV mode	
69		210 kΩ	NA-mute in	DC Mute: 3.5 V to 5 V Through: 0 V to 1.25 V	←	—
70		30 kΩ	NA-tuner in	 (Typ.) -29 dBV = 100 mV[p-p]	—	2.5
71		25 kΩ	NA V _{REF}	DC	←	2.5
72		—	NA-AGC det.	DC	←	—
73		30 kΩ	NA-line in	 (Typ.) -29 dBV = 100 mV[p-p]	—	2.5
74		Low	f _{VCO} adjustment pin	DC	DC	0.6
75	—	—	GND (for VCO)	—	—	0
76		20 kΩ	ACC output pin Y LPF output pin Killer output pin	 Low at killer	←	2.7

■ Terminal Equivalent Circuits (continued)

Pin No.	Equivalent circuit	Impe- dance (Z)	Description	Waveform		Voltage DC (V)
				EE mode	VV mode	
77		Rc	Rec. AFC, PB APC detection pin	DC	DC	2.1
78		EF	2f _{SC} output pin		←	2.7
79		High	Side lock detection pin	Side lock detec- tion current	←	—
80		EF	Xtal output pin 3.58 MHz		←	3.6
81	—	—	GND (chroma-system)	—	—	0
82		1 910 Ω	Xtal input pin		←	2.7
83		EF	Xtal output pin 4.43 MHz		←	3.6
84		EE 75 kΩ VV 75 kΩ	Rec. APC, f _H AFC detection pin	DC	←	2.4

Application Circuit Example

