

DBL 1085

PLL FM STEREO MULTIPLEX

DBL 1085 is a MPX IC for Car Stereo.
It contains SNC function and HCC function.

FUNCTIONS

- High cut control
- Stereo noise control
- VCO oscillation stop
- Automatic selection between stereo and mono

FEATURES

- Low distortion
- Good ripple of power supply
- Wide supply voltage range : $V_{CC}=6.5V\sim 14V$
- Input signal voltage range : $V_{IN}=200mV_{rms}\sim 300mV_{rms}$

APPLICATION

- Car stereo radio

MAXIMUM RATINGS ($T_a=25^\circ C$)

Characteristic	Symbol	Rating	Unit
Supply Voltage	V_{CC}	16	V
Lamp Driving Current	I_{LAMP}	30	mA
Power Dissipation	P_D	520	mW
Operating Temperature	T_{op}	$-20\sim +70$	$^\circ C$
Storage Temperature	T_{sto}	$-40\sim +125$	$^\circ C$

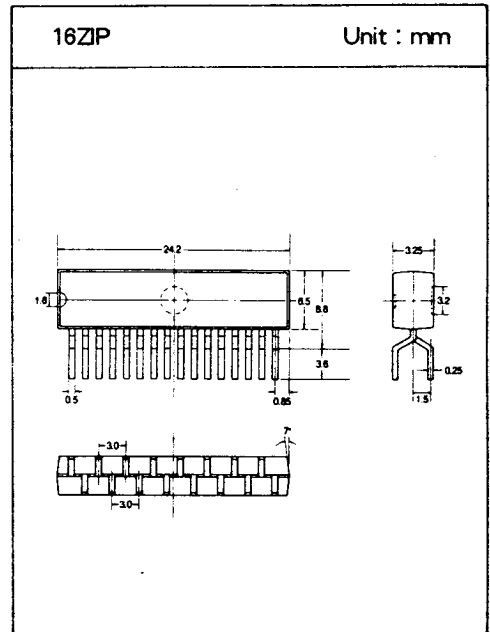

DBL 1085

BLOCK DIAGRAM AND APPLICATION CIRCUIT

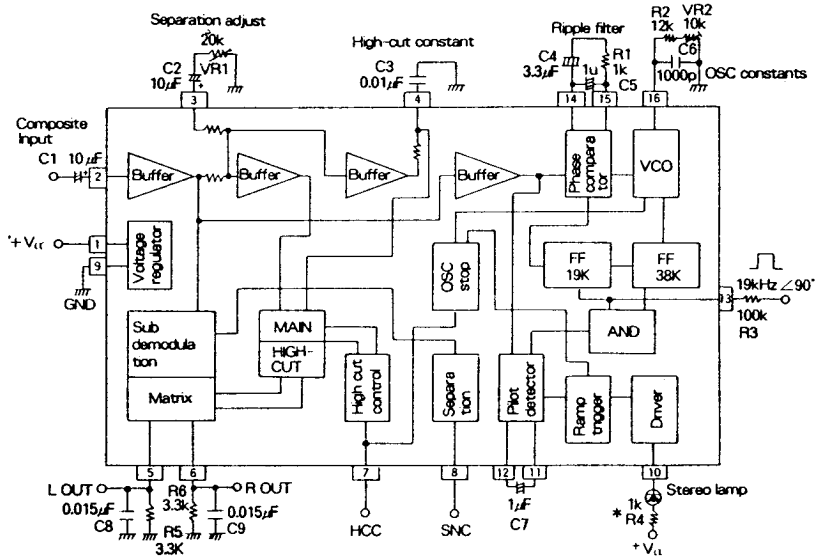

TEST CIRCUIT

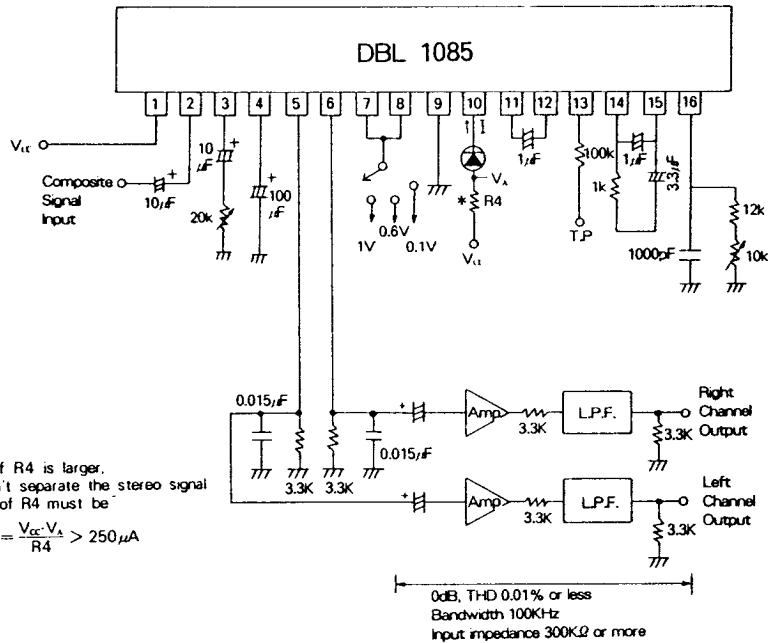

DBL 1085

ELECTRICAL CHARACTERISTICS

(Unless otherwise specified, $T_a=25^\circ\text{C}$, $V_{cc}=10\text{V}$, $V_{in}=300\text{mVrms}$, $f=1\text{kHz}$, $L+R=90\%$, $\text{Pilot}=10\%$)

Characteristic	Symbol	Test Condition	Min.	Typ.	Max.	Unit
Quiescent Current	I_{COO}	—	—	21	27	mA
Channel Separation	CH_{SEP}	—	40	50	—	dB
Monaurl THD	THD_{MO}	$V_N=300\text{mVrms}(\text{mono})$	—	0.05	0.2	%
Stereo THD	THD_{ST}	—	—	0.05	0.2	%
Lamp Turn-on Level	V_{LAMP}	—	60	85	120	mVrms
Capture Range	C.R.	—	—	± 3	—	%
Output voltage	V_{OUT}	—	140	200	280	mVrms
Signal to Noise Ratio	S/N	—	70	78	—	dB
Input Resistance	r_i	—	—	20	—	$K\Omega$
SCA Rejection Ratio	SCA_{rej}	—	—	80	—	dB
Allowable Input Voltage	V_N	THD=1%	700	800	—	mVrms
SNC Output Attenuation	$ATT_{(SNC)}$	$V_\delta=0.6\text{V}$, $L-R=90\%$	-8.5	-3.0	-0.3	dB
SNC Output Voltage	$V_{OUT(SNC)}$	$V_\delta=0.1\text{V}$, $L-R=90\%$	—	—	5	mVrms
HCC Output	$ATT_{(HCC1)}$	$V_\gamma=0.6\text{V}$	-15.0	-6.0	-0.5	dB
Attenuation	$ATT_{(HCC2)}$	$V_\gamma=1\text{V}$	-2.0	—	0	dB
Power Supply Ripple Rejection	R.R	—	—	35	—	dB
VCO Stop Voltage	VCO_{STOP}	—	—	6.8	—	V
Channel Balance	CH_{BAL}	—	—	0.5	1.5	dB
Hysteresis	Hy	—	—	3	6	dB

DBL 1085

□ INFORMATION IN USING IC

Stereo noise control and high cut control

The DBL 1085 has SNC and HCC terminals for improved S/N ratios when operating in weak radio fields. By adjusting the SNC terminal, noises unique to stereo FM in weak fields can be reduced. The HCC terminals permits further improvement of effective S/N ratios by lowering treble levels of FM noises in weak fields. (See Graph2)

STEREO deteriorates approximately 21.7dB (compared to MONO) in weak radio fields. (Graph 2) Generally, when S/N ratios deteriorate below 30 to 40 dB, noises become quite noticeable.

SNC is expected to function in region A, and HCC in region B. In region C, shallow muting is effected in the IF stage.

(1) SNC (stereo noise control)

Stereo S/N ratios deteriorate 21.7dB below monaural but can be improved by varying stereo separation. S/N improvement becomes apparent, however, only when the separation is 20dB or worse. In that case, the relation between separation and S/N improvement is shown in Graph 4.

SNC in the DBL 1085 improves S/N ratios in weak radio fields by varying separation. It varies subsignal demodulation level and controls separation. By using the IF stage signal meter level output as the source of the control signal, S/N ratios in region A of Graph 2 can be maintained at about 40dB or better. Ideal S/N enhancements should provide gradual switching over from stereo to monaural to maintain constant S/N ratios, starting from a point in region A for 40dB stereo S/N toward a point for 40dB monaural S/N.

Methods to set the control level will be described later.

Graph 3. shows voltages applied to pin 8 (SNC terminal) of DBL 1085 versus separation characteristics (SNC characteristics). Pin 8 is also the base of a PNP transistor, so stereo mode is set when pin 8 is open and monaural mode is set when it is grounded. SNC terminal control is effective only when locked with pilot signals and when stereo indicator is lit. External circuit parameters can be chosen in large values that do not affect the IF stage meter output circuit because SNC control currents are small. This makes designing easy. (See Graph 5)

(2) HCC (high-cut control)

In region B where S/N deteriorates to 40dB or worse even for monaural, the S/N as sensed by the human ear can be enhanced by suppressing levels at frequencies above approximately 7kHz. Treble region levels that follow meter voltages can be smoothly attenuated (high-cut control) by impressing IF stage signal meter output to the HCC pin (pin 7) of the DBL 1085. Graph 6 shows MPX output frequency characteristics (monaural) provided by voltage impressed on pin 7. Frequency characteristics for a 100% high cut can be designated by an external capacitor connected to pin 4. An equivalent circuit is shown below where the designation is made by the 5kohm and the C time constant. Approximate values provided by C as expressed in attenuation at 10kHz are listed in table below :

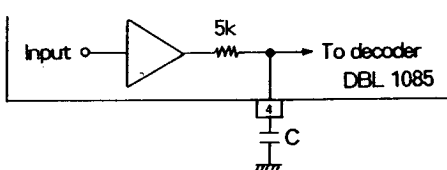

C [μ F]	Attenuation at 10kHz (dB)
0.01	-11
0.033	-21
0.047	-25
0.068	-28

DBL 1085

□ INFORMATION IN USING IC (Continued)

Graph 7 shows the relation between voltages impressed on pin 7 and rates(%) of high cut(HCC). When IF meter output voltage characteristics and region B, S/N characteristics, of Graph 2 have been obtained, S/N improvement by HCC can be drawn in a way similar to drawing SNC characteristics.

Graph 2 shows typical meter outputs of a quadrature detection IF amplifier IC. (Graph 1 Shows data for DBL 1018) HCC characteristics have been designated to permit region B improvements when the IC is directly connected to HCC(pin 7) terminal of DBL 1085. The infinitesimal control currents at pin 7, similar to pin 8, do not affect meter outputs.

(3) SNC and HCC connection circuits when coupled with the IF stage

Graph 1 shows sample S/N characteristics vs antenna inputs when SNC and HCC are connected with the IF stage by an external circuit.

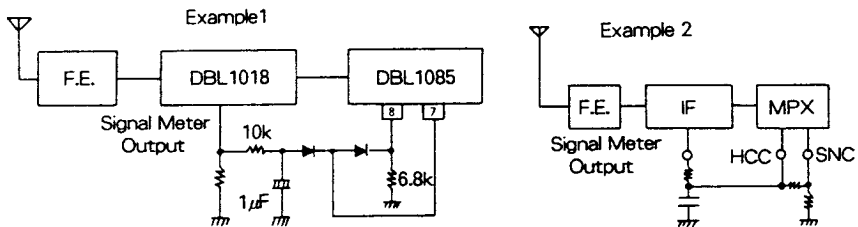

(4) S/N improvements in region C of Graph 1

Because S/N ratios deteriorate even further in the region C of Graph 1, it is better to improve the S/N in this region with IF mutings. The DBL 1018 is available to linearly vary the IF muting. Employment of the DBL 1085 together with the DBL 1018 further enhances S/N improvement.

(5) Using the HCC terminal for muting

Mutings in the neighborhood of 37dB are feasible by utilizing HCC functions as muting functions when used in home stereos and no need exists to suppress treble noises. Fade-in and fade-out of mutings, permitting delightful, shock-noise-free muting are possible by providing a time constant to the pin 7 control.

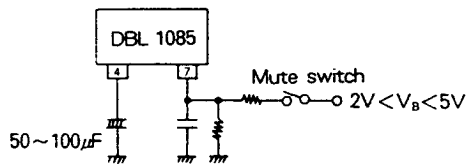

(6) VCO damping

VCO oscillations can be damped by applying a voltage not less than 7V to the HCC terminal (pin 7) to induce a monaural mode. At this time, both SNC and HCC are in an off mode. Graph 8 Shows in-flow current by pin 7 applied voltages.

TYPICAL PERFORMANCE CHARACTERISTICS

Weak radio field S/N improvements by the system (Graph 1)

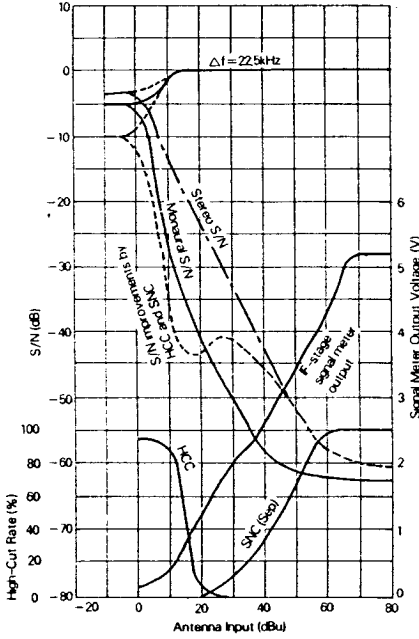

SNC/HCC Operating Regions (Graph 2)

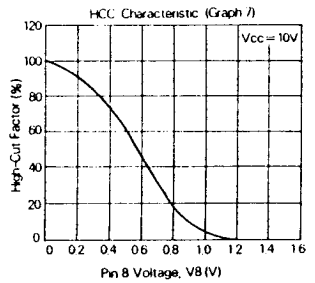
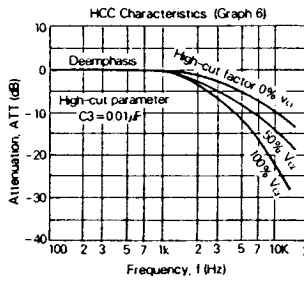
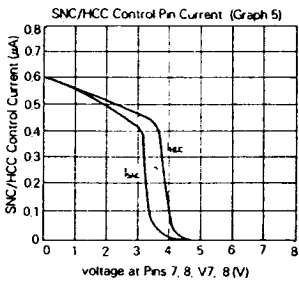
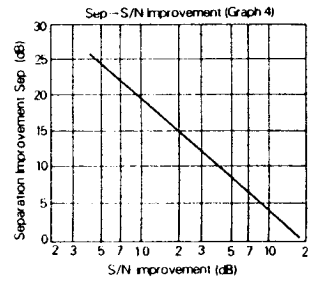
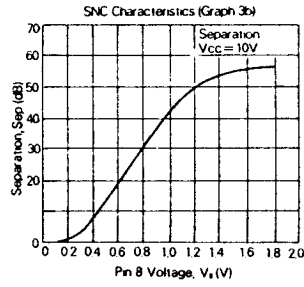
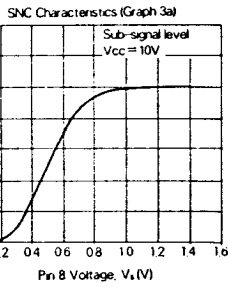
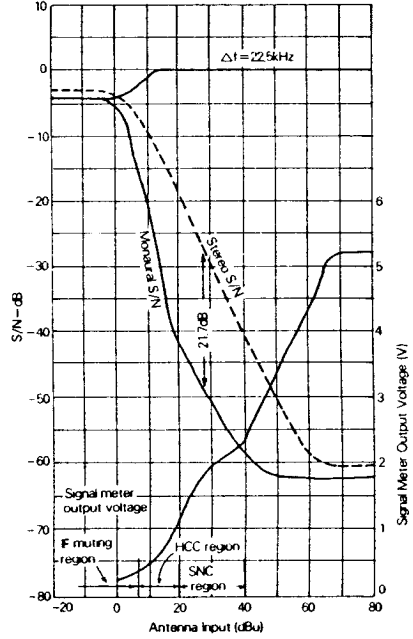

TYPICAL PERFORMANCE CHARACTERISTICS (Continued)

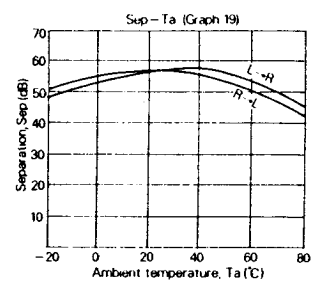
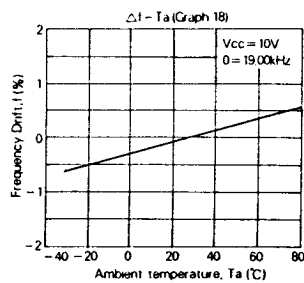
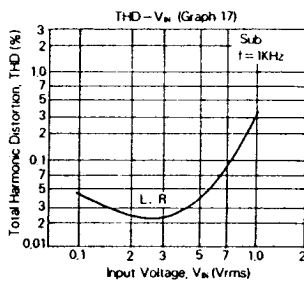
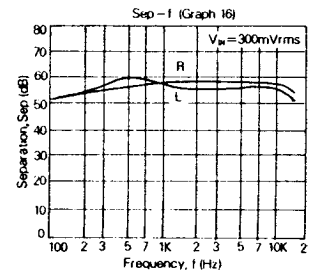
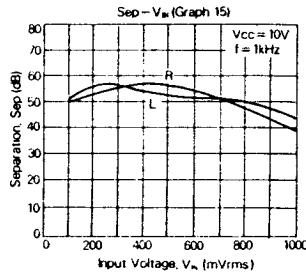
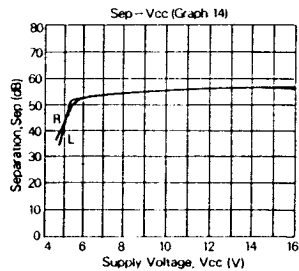
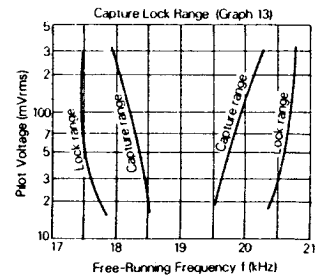
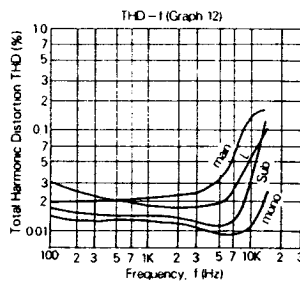
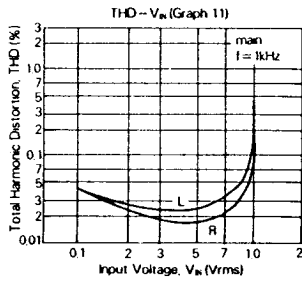
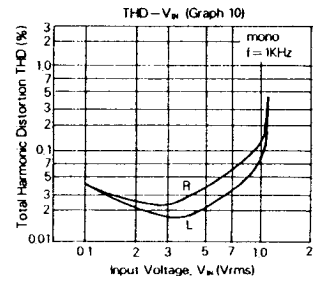
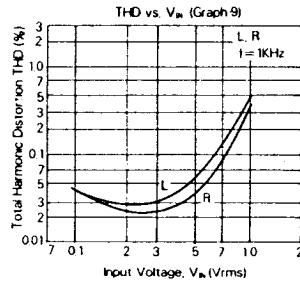
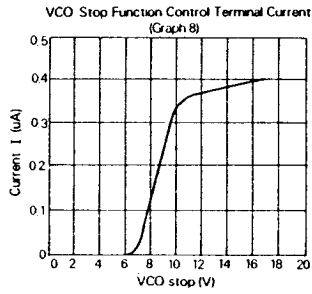

This datasheet has been download from:

www.datasheetcatalog.com

Datasheets for electronics components.