

## TV SOUND SYSTEM

The KA2102A is a silicon monolithic integrated circuit designed for the SIF and audio section in television receivers. This IC has all functions including sound IF amplifier, FM detector, DC volume control circuit, audio output amplifier with 2.4 Watts output power and voltage regulator. This IC is encapsulated in a 14-pin dual in-line package with heat tab.

## FEATURES

- Wide power supply range, 9V ~ 18V  
 2.4 Watt, at  $V_{CC}=18V$ ,  $R_L=8\Omega$  (For 17" TV)  
 1.2 Watt, at  $V_{CC}=12V$ ,  $R_L=8\Omega$  (For 12" TV)
- Linear volume control
- Low harmonic distortion
- Differential peak detector
- Enough attenuation (Typ, 80dB) by squelch circuit

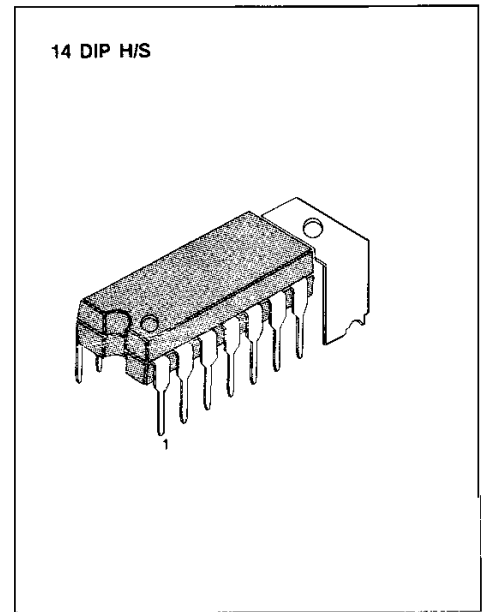

## ORDERING INFORMATION

Device	Package	Operating Temperature
KA2102A	14 DIP H/S	-20 ~ +75°C

## TYPICAL APPLICATION CIRCUIT

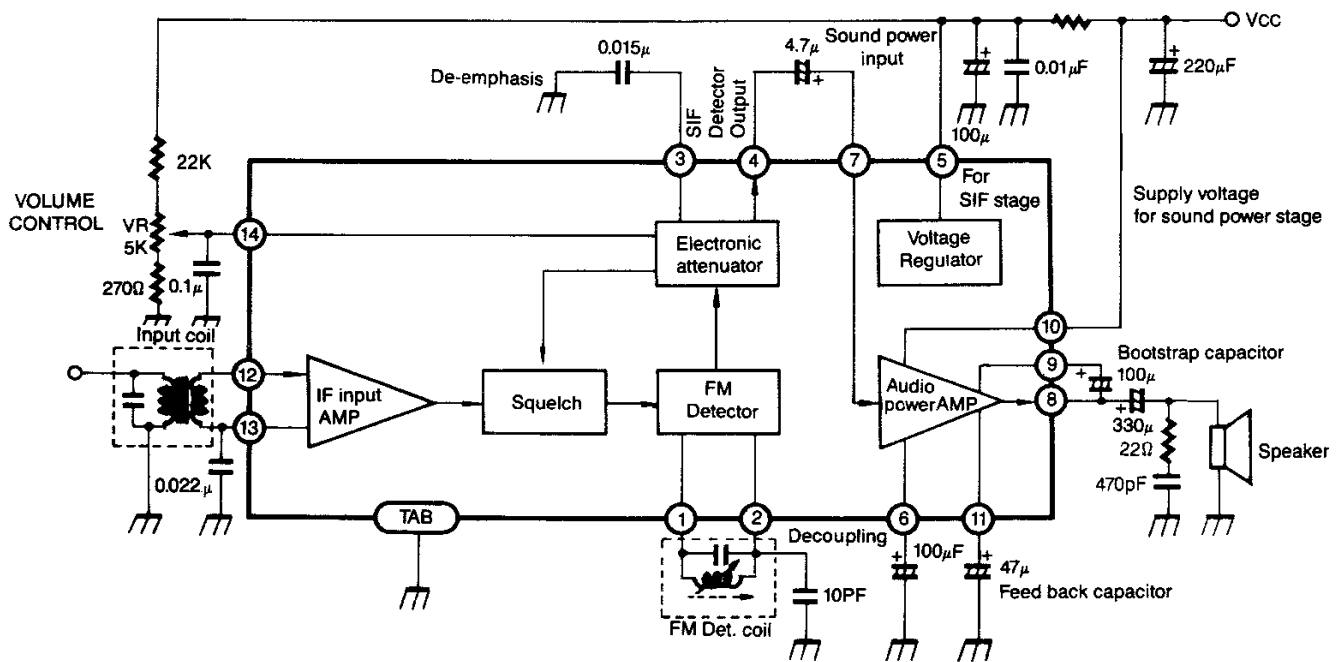

Fig. 1

**ABSOLUTE MAXIMUM RATINGS (T<sub>a</sub>=25°C)**

Characteristic	Symbol	Value	Unit
Supply Voltage (Pin 10)	V <sub>10</sub>	20	V
Supply Current (Pin 10)	I <sub>10</sub>	1	A
Supply Current (Pin 5)	I <sub>5</sub>	100	mA
Input Signal Voltage	V <sub>i</sub>	3	V <sub>p-p</sub>
Power Dissipation	P <sub>D1</sub>	0.8 (T <sub>a</sub> =75°C) free air	W
Power Dissipation	P <sub>D2</sub>	1.4*	W
Operating Temperature	T <sub>OPR</sub>	-20 ~ +75	°C
Storage Temperature	T <sub>STG</sub>	-40 ~ +150	°C

\* Printed Circuit Copper Area 50×50mm<sup>2</sup>**ELECTRICAL CHARACTERISTICS (T<sub>a</sub>=25°C)**1. IF STAGE (V<sub>CC</sub>=12V, R<sub>B</sub>=100Ω, V<sub>14</sub>≥1.3V, fo=4.5MHz, fm=400Hz, f= ±25KHz, R<sub>g</sub>=50μΩ)

Characteristic	Symbol	Test Conditions	Min	Typ	Max	Unit
Pin 5 Voltage	V <sub>5A</sub>		7.5	8.0	8.5	V
Pin 5 Voltage	V <sub>5B</sub>	V <sub>CC</sub> =18V, R <sub>B</sub> =330Ω	7.5	8.0	8.5	V
Pin 10 Current	I <sub>10A</sub>	No Input Signal	14	19	24	mA
Pin 10 Current	I <sub>10B</sub>	V <sub>CC</sub> =18V, R <sub>B</sub> =330Ω No Input Signal	16	28	35	mA
IF Limiting Voltage	V <sub>LIM</sub>	V <sub>OAF</sub> (V <sub>i</sub> =10mVrms). -3dB	—	200	400	μVrms
Detector Output Voltage	V <sub>OAF</sub>	V <sub>i</sub> =10mVrms	300	360	—	mVrms
Detector Distortion	THD <sub>1</sub>	V <sub>i</sub> =10mVrms	—	0.7	—	%
AM Rejection	AMR	AM Mod 30% fm=400Hz V <sub>i</sub> =10mVrms	-40	-50	—	dB
Maximum Attenuation	V <sub>ATT</sub>	V <sub>14</sub> =0V	-60	-80	—	dB

2. SOUND POWER STAGE (V<sub>CC</sub>=12V, R<sub>B</sub>=100Ω, R<sub>L</sub>=8Ω, f=400Hz, R<sub>G</sub>=600Ω)

Characteristic	Symbol	Test Conditions	Min	Typ	Max	Unit
Sound Stage Voltage Gain	G <sub>VAF</sub>	V <sub>i</sub> =30mVrms	33	37	41	dB
Sound Output Power	P <sub>OA</sub>	THD=10%	0.9	1.2	—	W
Sound Output Power	P <sub>OB</sub>	V <sub>CC</sub> =18V, R <sub>B</sub> =330Ω THD=10%	2.0	2.4	—	W
Sound Output Distortion	THD <sub>2A</sub>	P <sub>o</sub> =0.5W	—	0.6	2.0	%
Sound Output Distortion	THD <sub>2B</sub>	V <sub>CC</sub> =18V, R <sub>B</sub> =330Ω P <sub>o</sub> =0.5W	—	0.5	2.0	%
Overall Sound Output Distortion (IF + Sound Power Stage)	THD <sub>3</sub>	P <sub>o</sub> =0.5W V <sub>i</sub> =10mVrms	—	1.5	4.0	%

3. TYPICAL DATA

Characteristic	Symbol	Test Conditions	Value	Unit
Pin 10 Current	$I_{10}$	THD <sub>2A</sub> = 10%	200-210	mA
Pin 10 Current	$I_{10}$	THD <sub>2B</sub> = 10%	270-280	mA
Sound Output Power	$P_{OA}$	THD = 3%	1.1	W
Sound Output Power	$P_{OB}$	V <sub>CC</sub> = 18V, R <sub>B</sub> = 330Ω THD = 3%	2.0	W
Sound Stage Band Width	fs	-3dB	50 ~ 50K	Hz

TEST CIRCUIT

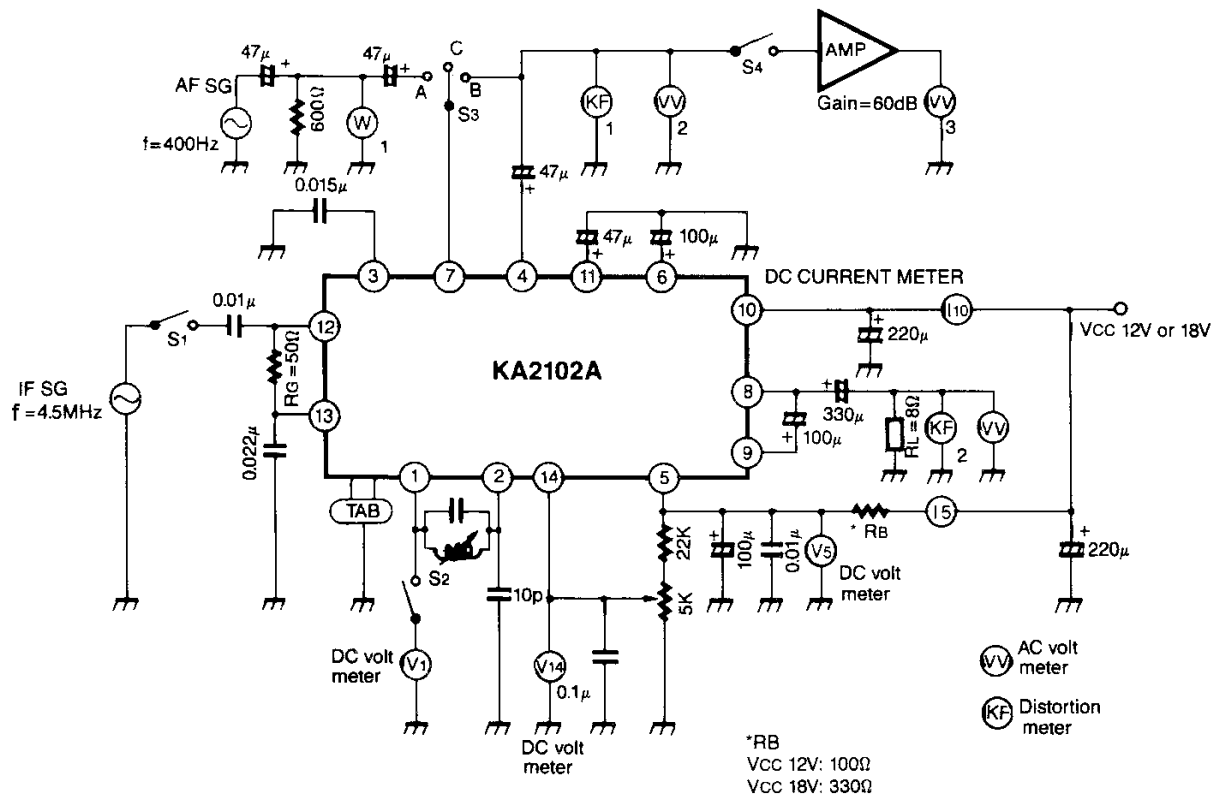
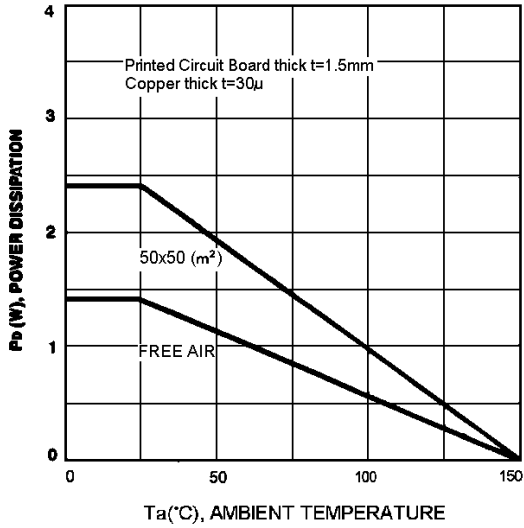
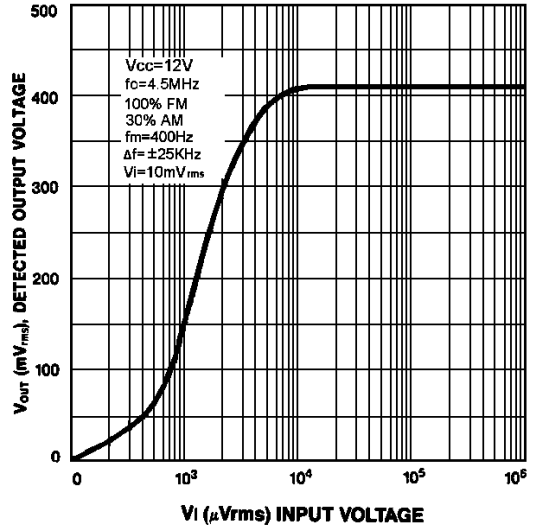

Fig. 2

POWER DISSIPATION



DETECTED OUTPUT VOLTAGE



SUPPLY CURRENT

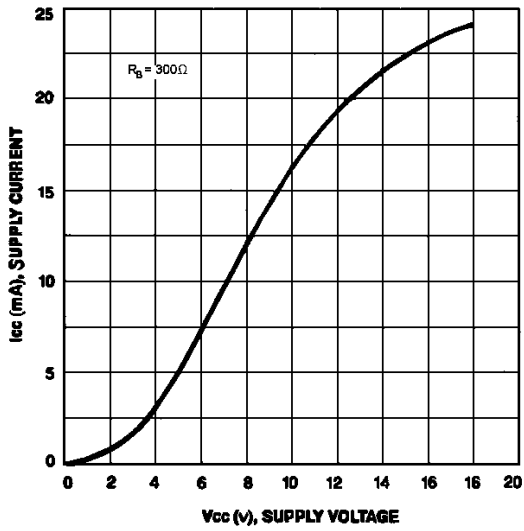

OUTPUT POWER (AUDIO AMPLIFIER)

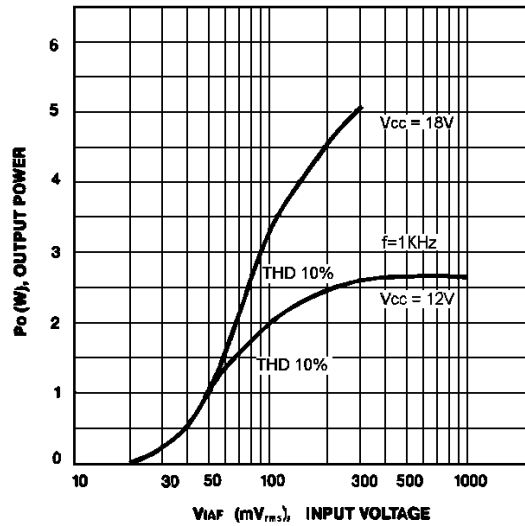

TOTAL HARMONIC DISTORTION

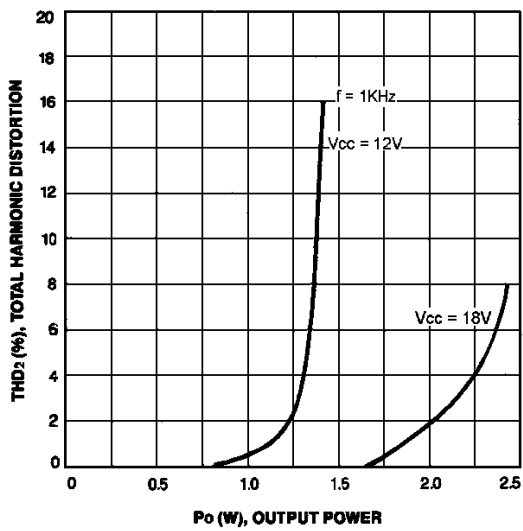

FREQUENCY RESPONSE (AUDIO AMPLIFIER)

