



# LA4630N

## 9V/12V 3-Dimension Power IC for Radio Cassette Recorders

### Features

- Stereo section 9V/3Ω 3W×2, 12V/3Ω 5W×2 : NF-capacitorless power
  - Super bass section 9V/3Ω 6W, 12V/3Ω 10W : output capacitor, B-S capacitorless power
- This chip employs technology for eliminating pins and external connections to realize 3-dimensional power on a single chip. This IC is a single package power IC for making sound systems with punch.
- On-chip pop noise suppressor
  - On-chip power switch circuit
  - External and mute functions on chip.
  - Protection functions on chip (thermal protection circuit and BTL section  $R_L$  short protection circuit)

### Package Dimensions

unit:mm

3109A-SIP18H

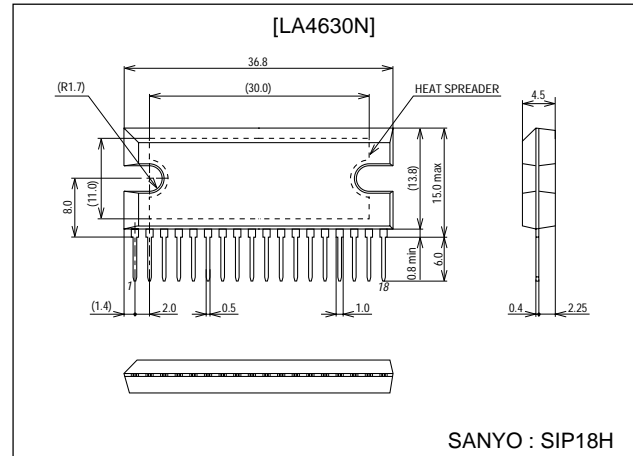

### Specifications

Maximum Ratings at  $T_a = 25^\circ\text{C}$ 

Parameter	Symbol	Conditions	Ratings	Unit
Maximum supply voltage	$V_{CC \text{ max}}$	*1 no signal	20	V
Thermal resistance	$\theta_{j-c}$		2	$^\circ\text{C/W}$
Maximum output current	$I_{O \text{ peak}}$		3	A
Allowable power dissipation	$P_d \text{ max}$	With infinite heat sink	37.5	W
Operating temperature	$T_{opr}$		-20 to +75	$^\circ\text{C}$
Storage temperature	$T_{stg}$		-40 to +150	$^\circ\text{C}$

Recommended Operating Conditions at  $T_a = 25^\circ\text{C}$ 

Parameter	Symbol	Conditions	Ratings	Unit
Recommended supply voltage	$V_{CC}$		9	V
			12	V
Recommended load resistance	$R_L$		3 to 8	$\Omega$
Operating voltage	$V_{CC \text{ op}}$	*2	5 to 18	V

Continued on next page.

■ Any and all SANYO products described or contained herein do not have specifications that can handle applications that require extremely high levels of reliability, such as life-support systems, aircraft's control systems, or other applications whose failure can be reasonably expected to result in serious physical and/or material damage. Consult with your SANYO representative nearest you before using any SANYO products described or contained herein in such applications.

■ SANYO assumes no responsibility for equipment failures that result from using products at values that exceed, even momentarily, rated values (such as maximum ratings, operating condition ranges, or other parameters) listed in products specifications of any and all SANYO products described or contained herein.

**SANYO Electric Co., Ltd. Semiconductor Company**

TOKYO OFFICE Tokyo Bldg., 1-10, 1 Chome, Ueno, Taito-ku, TOKYO, 110-8534 JAPAN

# LA4630N

Continued from preceding page.

\*1 : Operational notes on the maximum supply voltage.

FRONT L/R	BTL	V <sub>CC</sub> max	Conditions
R <sub>L</sub> ≥ 3Ω	R <sub>L</sub> ≥ 3Ω	20V	No signal Front L/R input with capacitor Rg=0 BTL L/R input without capacitor Rg=0
R <sub>L</sub> ≥ 3Ω	R <sub>L</sub> ≥ 4Ω	21V	
R <sub>L</sub> ≥ 3Ω	R <sub>L</sub> ≥ 5Ω	22V	
R <sub>L</sub> ≥ 3Ω	R <sub>L</sub> ≥ 6Ω	23V	
R <sub>L</sub> ≥ 3Ω	R <sub>L</sub> ≥ 7Ω	24V	
R <sub>L</sub> ≥ 3Ω	R <sub>L</sub> ≥ 8Ω	24V	

For power supply transistor regulation, the equivalent power line resistance is 3Ω or greater.

\*2 : The upper limit for V<sub>CC</sub> op is V<sub>CC</sub> max – 2V.

## [Design Note]

Select the target P<sub>O</sub> under the a rated load/rated supply voltage conditions of R<sub>L</sub>=3 to 8Ω and V<sub>CC</sub>=5 to 18V. Make sure that it does not exceed the package Pd max of 37.5W. Note that heavy load and high V<sub>CC</sub> conditions would bring about power efficiency deterioration depending on the drive design employed.

## Operating Characteristics at Ta = 25°C, V<sub>CC</sub>=9V, R<sub>L</sub>=3Ω, f=1kHz

Parameter	Symbol	Conditions	Ratings			Unit
			min	typ	max	
Quiescent flow-in current	I <sub>CCO</sub>		35	70	140	mA
Standby current	I <sub>ST</sub>			1.0	10.0	μA
Power switch pin flow-in current	I <sub>SW</sub>			10.0		mA
Mute supply flow-in current	I <sub>CCm</sub>			35.0	70.0	mA
[Stereo Section]						
Output power	P <sub>O1</sub>	V <sub>CC</sub> =9V, THD=10%	2.2	3.0		W
	P <sub>O2</sub>	V <sub>CC</sub> =12V, THD=10%	4.2	5.0		W
Total harmonic distortion	THD	V <sub>O</sub> =1V		0.20	1.0	%
Input resistance	R <sub>i</sub>			50		kΩ
Voltage gain	VG		43	45	47	dB
Output noise voltage	V <sub>NO</sub>	Rg=0, BPF=20Hz to 20kHz		0.15	0.40	mV
Ripple rejection	SVRR	f <sub>R</sub> =100Hz, V <sub>R</sub> =0dBm	45	55		dB
Channel separation	CH sep	Rg=10kΩ, V <sub>O</sub> =0dBm	45	50		dB
Muting attenuation	A <sub>tt</sub>	V <sub>O</sub> =0dBm		80		dB
Low-region roll off frequency	f <sub>L</sub>	VG=-3dB		50		Hz
High-region roll off frequency	f <sub>H</sub>	VG=-3dB		50		kHz
[Super Bass Section]						
Output power	P <sub>O1</sub>	V <sub>CC</sub> =9V, THD=10%	5.0	6.0		W
	P <sub>O2</sub>	V <sub>CC</sub> =12V, THD=10%	8.0	10.0		W
Total harmonic distortion	THD	V <sub>O</sub> =1V		0.20	1.0	%
Input resistance	R <sub>i</sub>			30		kΩ
Voltage gain	VG		43	45	47	dB
Output noise voltage	V <sub>NO</sub>	Rg=0, BPF=20Hz to 20kHz		0.3	0.6	mV
Ripple rejection	SVRR	f <sub>R</sub> =100Hz, V <sub>R</sub> =0dBm	50	60		dB
Muting attenuation	A <sub>tt</sub>	V <sub>O</sub> =0dBm		80		dB
Low-region roll off frequency	f <sub>L</sub>	VG : -3dB		5		Hz
High-region roll off frequency	f <sub>H</sub>	VG : -3dB		40		kHz
Output offset voltage	V <sub>OFF</sub>	Rg=0	-150		+150	mV

# LA4630N

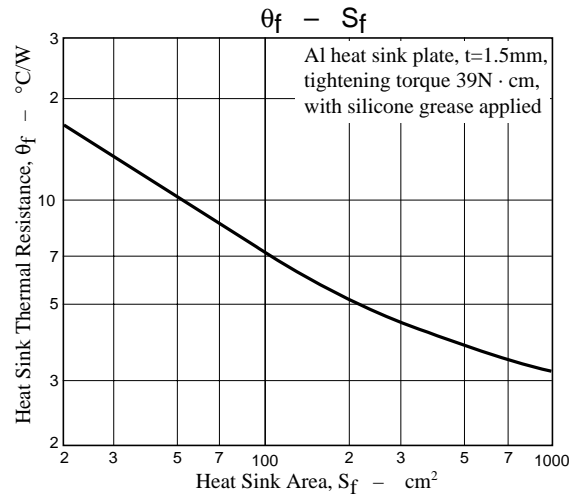
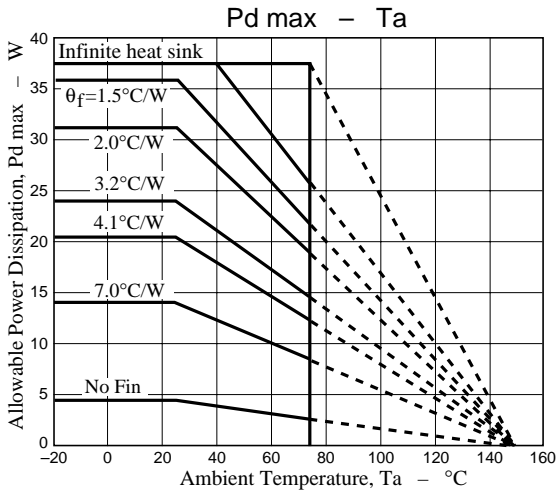

## Block Diagram

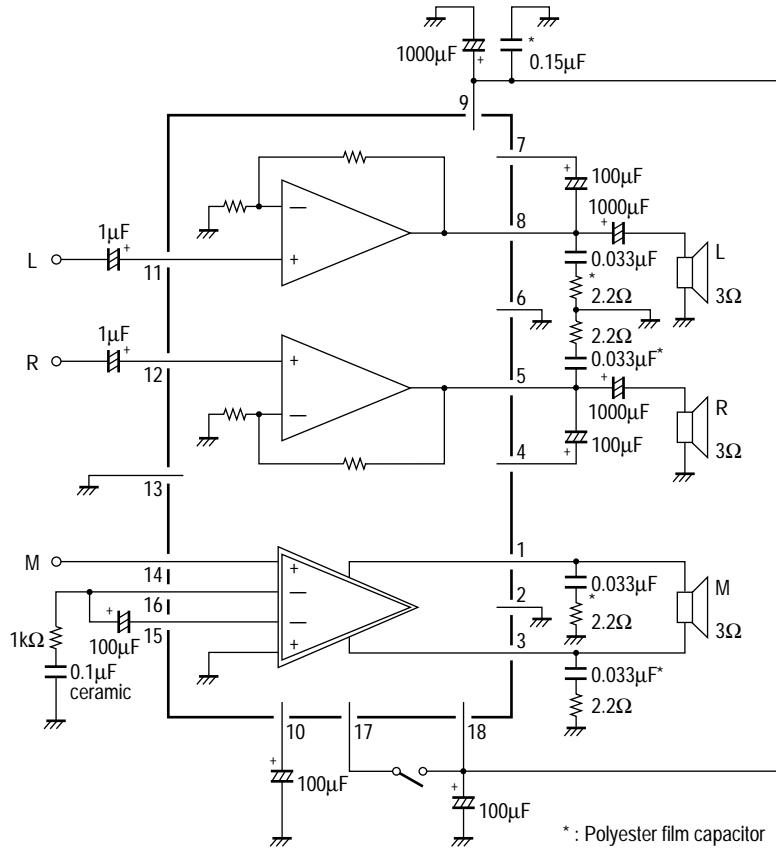

Note 1 : The motor should not be connected to the power switch pin since transient noise may appear on the amplifier outputs when the motor is started or stopped.

Note 2 : Audio mute is enabled by connecting a 300Ω resistance between the DC pin (pin 10) and ground. DC bias control of both the stereo (L ch, R ch) and BTL (super bass) channels is there enabled, and all audio output signals can be muted by controlling the MUTE pin.

# LA4630N

## Sample Printed Circuit Pattern

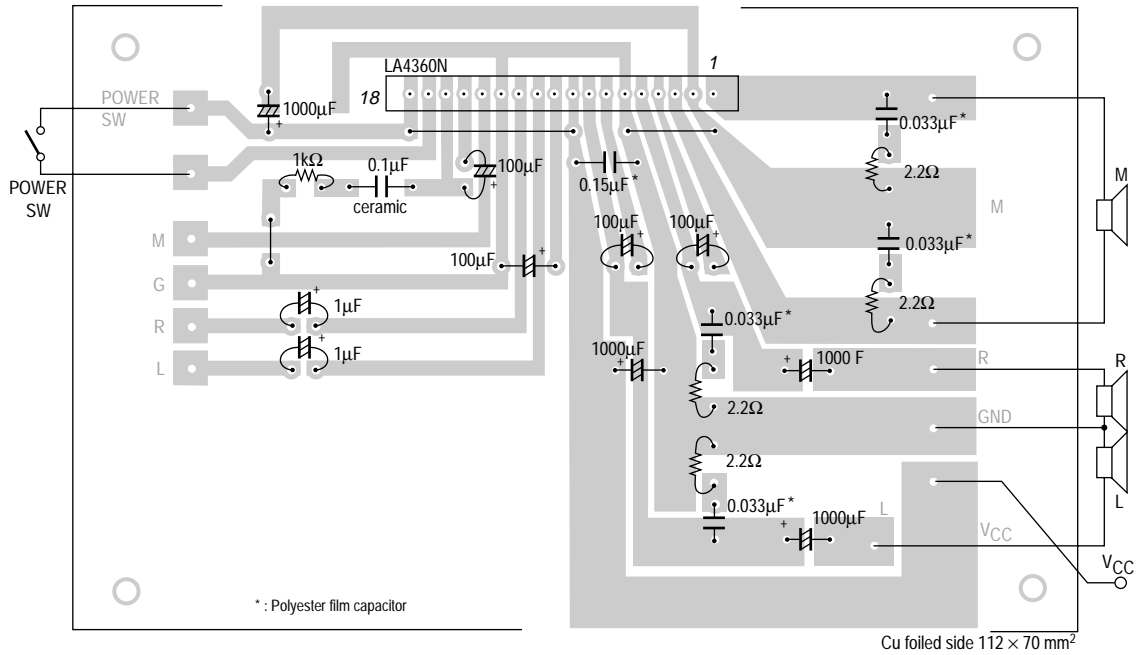

\* : Insert 0.15μF between power supply and ground at the root of the pins.

## Pin Voltages

Pin No.	1	2	3	4	5	6	7	8	9
Name	OUT No	PWR GND 2	OUT Inv	BS R	OUT R	PWR GND 1	BS L	OUT L	V <sub>CC</sub> 1
Pin Voltage (V)	4.0	0	4.0	8.1	4.5	0	8.1	4.0	9.0

Pin No.	10	11	12	13	14	15	16	17	18
Name	DC	IN L	IN R	PRE GND	IN No	NF Inv	NF No	PWR SW	V <sub>CC</sub> 2
Pin Voltage (V)	4.5	1.4	1.4	0	21 [mV]	1.4	1.4	9.0	9.0

## P<sub>O</sub> Chart

(THD=10%)

Item	R <sub>L</sub>	9V	12V	15V
FRONT L/R	8Ω	1.4W	2.5W	3.9W
	6Ω	1.75W	3.2W	5.0W
	4Ω	2.4W	4.3W	6.4W
	3Ω	3.2W	5.6W	—
	BTL	8Ω	3.2W	6.4W
	6Ω	4.0W	8.1W	13.5W
	4Ω	5.3W	10.4W	—
	3Ω	6.4W	12.4W	—

## P<sub>d</sub> max Chart

Item	R <sub>L</sub>	9V	12V	15V
FRONT L/R	8Ω	2.0W	3.2W	4.6W
	6Ω	2.4W	3.8W	5.7W
	4Ω	3.1W	5.0W	5.4W
	3Ω	3.8W	6.2W	—
	BTL	8Ω	2.8W	4.8W
	6Ω	3.6W	6.0W	9.0W
	4Ω	5.0W	8.8W	—
	3Ω	6.3W	11.2W	—

# LA4630N

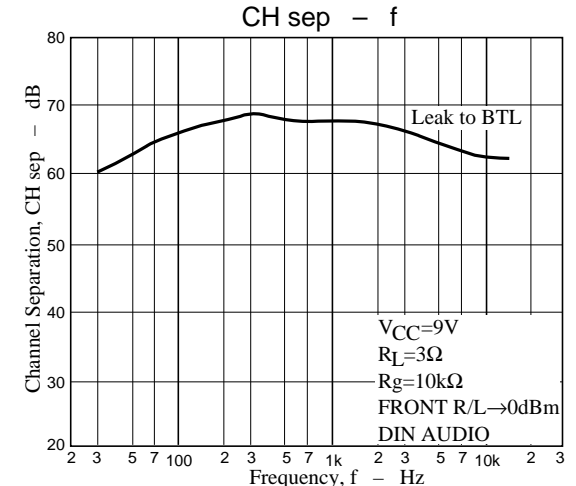
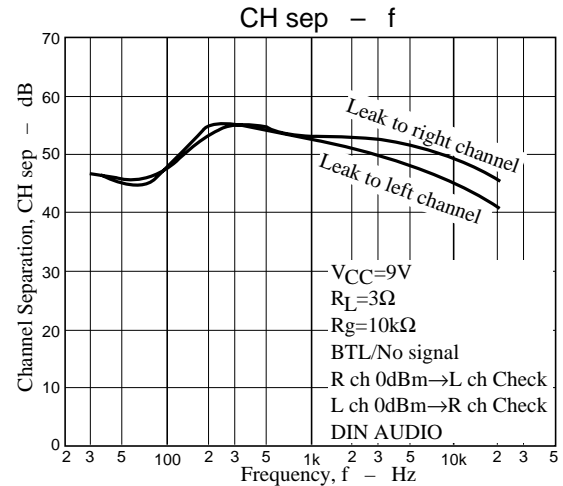
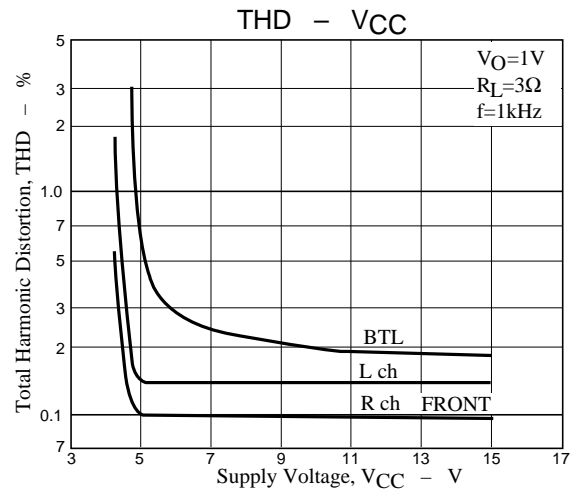
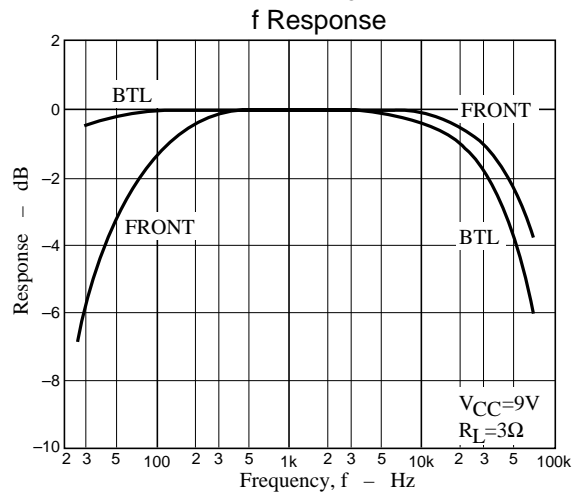
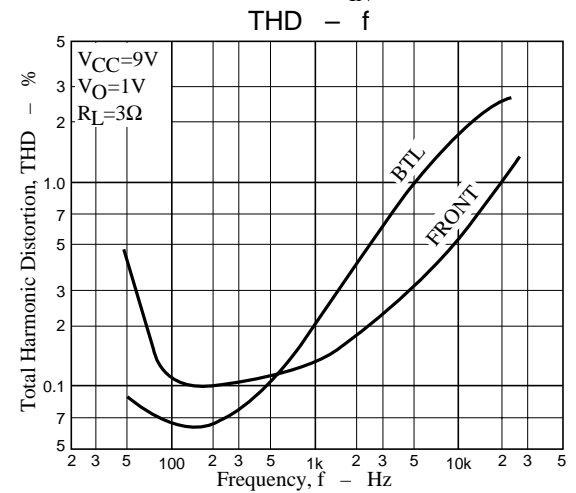
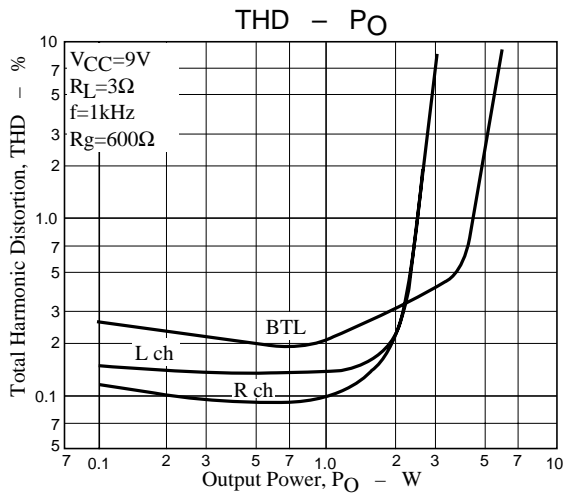
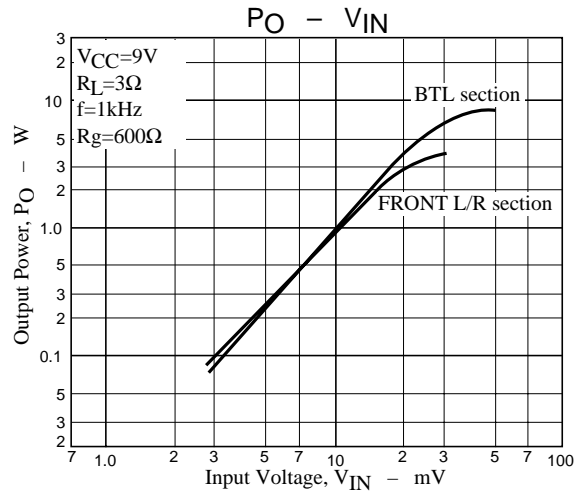
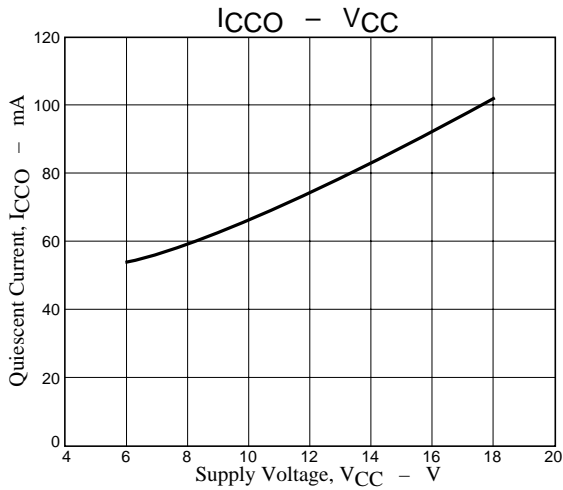

# LA4630N

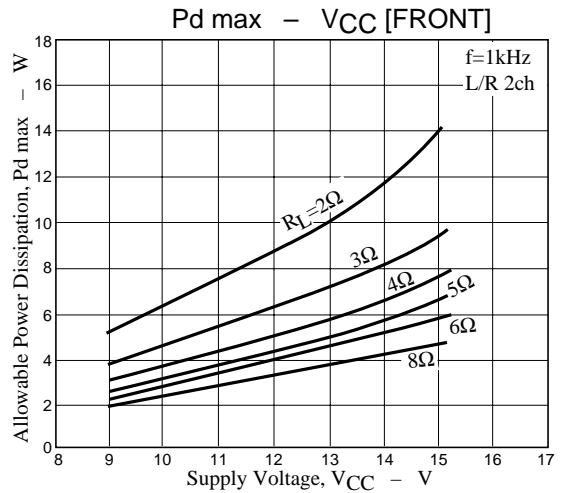
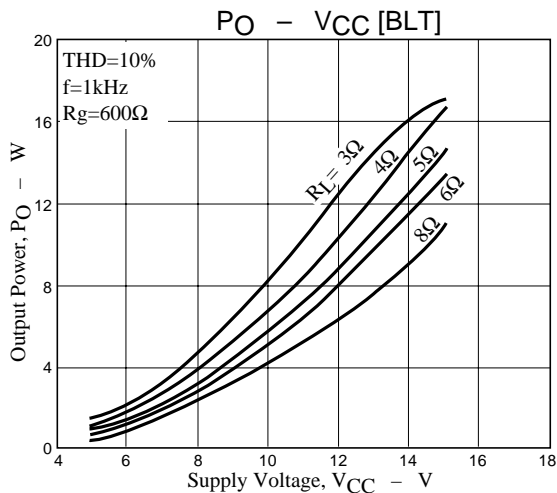
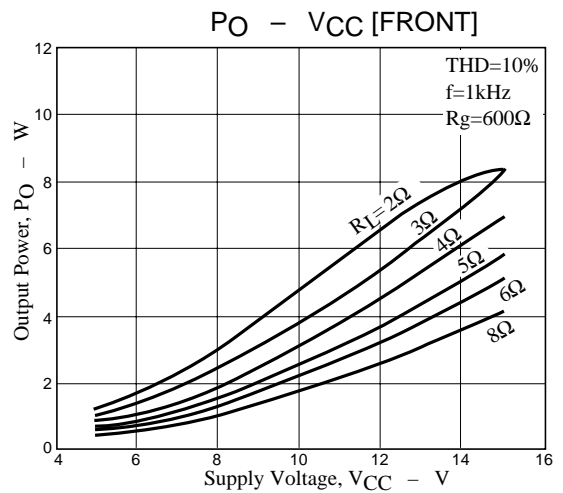
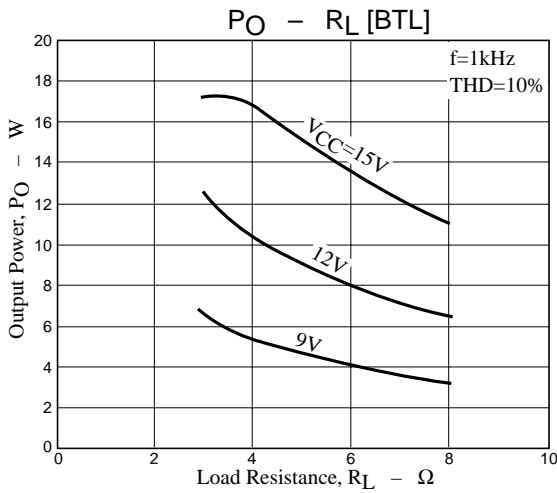
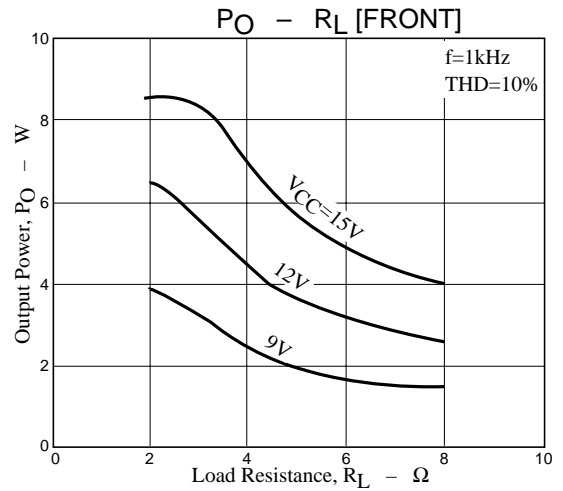
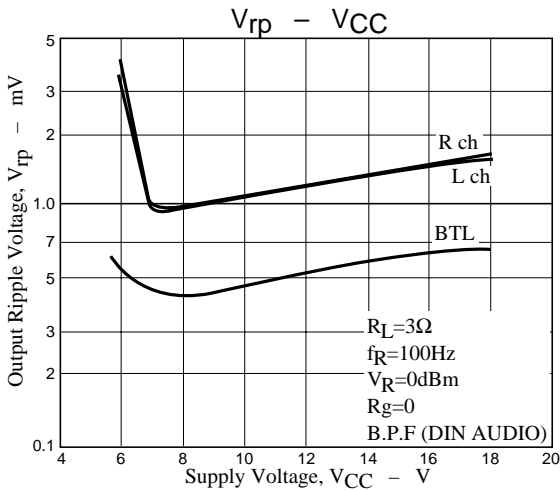
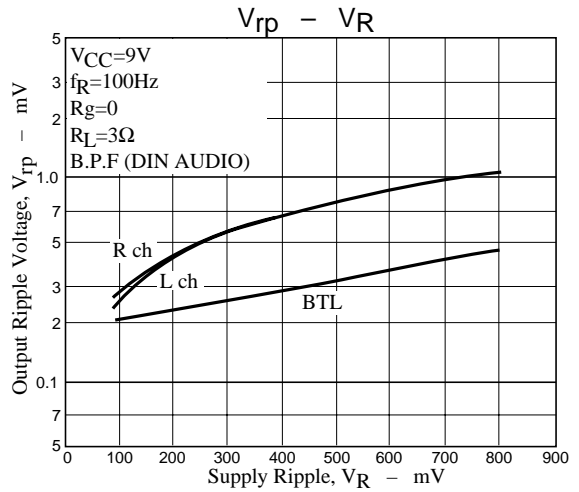
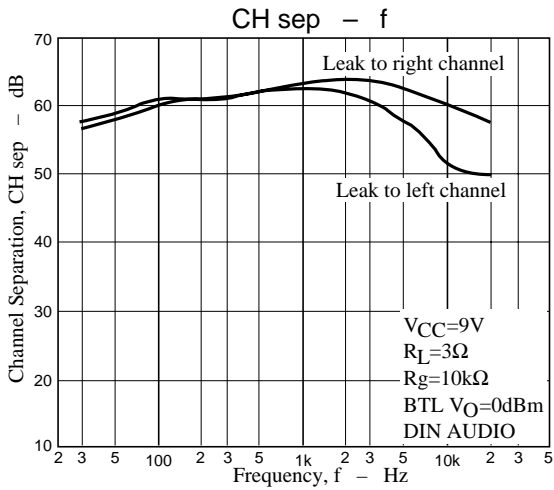

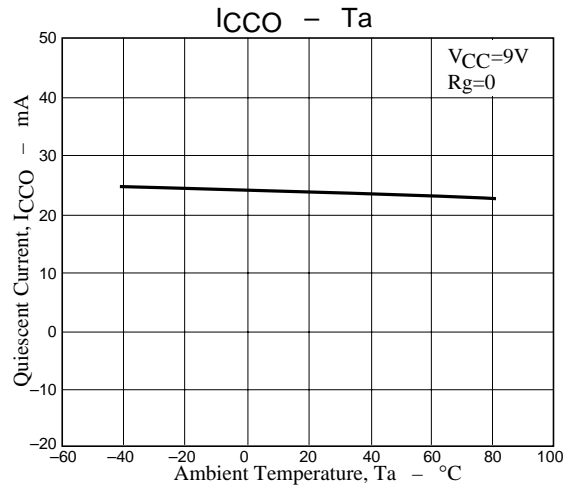
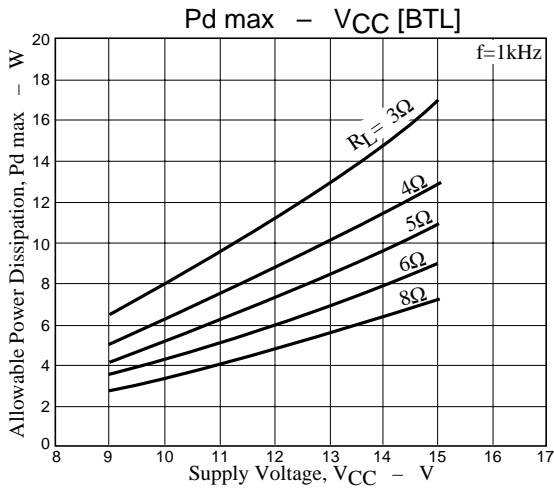

**Notes on using this IC**

- Always short power supply pins 9 and 16 on the copper foil of the printed circuit pattern and apply the equivalent power supply voltage.
- Pin 17 is designed for the power switch.  
It can be switched on and off with a small current capacity switch, but the point to watch out for is that if the voltage loss between pins 17 and 18 is too large, there may be problems in the biasing and the power may drop.
- When switching with a transistor, the general practice is to insert a PNP transistor between pins 17 and 18.

**Notes on Mounting Radiator Fin**

1. The tightening torque should be in the range of 39 to 59N · cm.
2. The distance between screw holes of the radiator fin must coincide with the distance between screw holes of the IC.  
With case outline dimensions L and R referred to, the screws must be tightened with the distance between them as close to each other as possible.

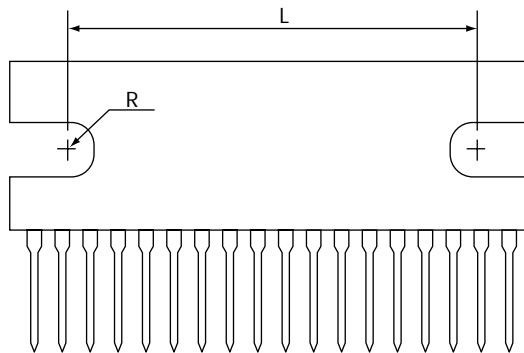

3. The screw to be used must have a head equivalent to the one of truss machine screw or binder machine screw defined by JIS. Washers must be also used to protect the IC case.
4. No foreign matter such as cutting particles must exist between heat sink and radiator fin. When applying grease on the junction surface, it must be applied uniformly on the whole surface.
5. IC lead pins must be soldered to the printed circuit board after the radiator fin is mounted on the IC.

- Specifications of any and all SANYO products described or contained herein stipulate the performance, characteristics, and functions of the described products in the independent state, and are not guarantees of the performance, characteristics, and functions of the described products as mounted in the customer's products or equipment. To verify symptoms and states that cannot be evaluated in an independent device, the customer should always evaluate and test devices mounted in the customer's products or equipment.
- SANYO Electric Co., Ltd. strives to supply high-quality high-reliability products. However, any and all semiconductor products fail with some probability. It is possible that these probabilistic failures could give rise to accidents or events that could endanger human lives, that could give rise to smoke or fire, or that could cause damage to other property. When designing equipment, adopt safety measures so that these kinds of accidents or events cannot occur. Such measures include but are not limited to protective circuits and error prevention circuits for safe design, redundant design, and structural design.
- In the event that any or all SANYO products(including technical data, services) described or contained herein are controlled under any of applicable local export control laws and regulations, such products must not be exported without obtaining the export license from the authorities concerned in accordance with the above law.
- No part of this publication may be reproduced or transmitted in any form or by any means, electronic or mechanical, including photocopying and recording, or any information storage or retrieval system, or otherwise, without the prior written permission of SANYO Electric Co., Ltd.
- Any and all information described or contained herein are subject to change without notice due to product/technology improvement, etc. When designing equipment, refer to the "Delivery Specification" for the SANYO product that you intend to use.
- Information (including circuit diagrams and circuit parameters) herein is for example only ; it is not guaranteed for volume production. SANYO believes information herein is accurate and reliable, but no guarantees are made or implied regarding its use or any infringements of intellectual property rights or other rights of third parties.

This catalog provides information as of November, 2003. Specifications and information herein are subject to change without notice.