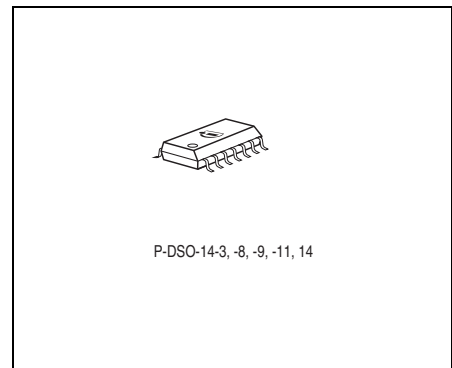
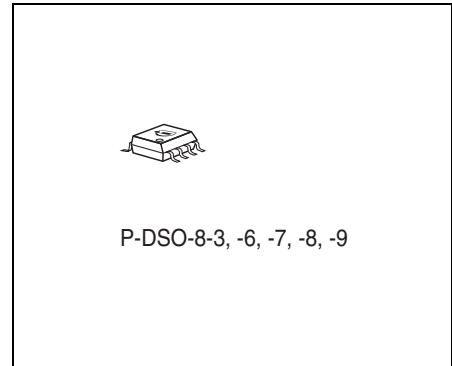


## Features

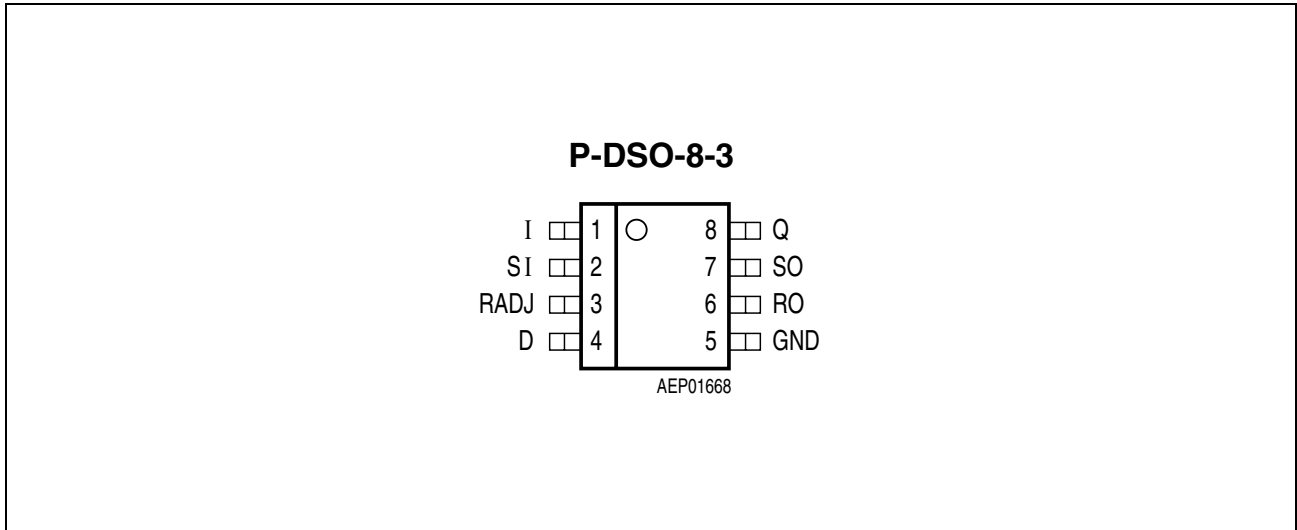
- Output voltage tolerance  $\leq \pm 2\%$
- 150 mA current capability
- Very low current consumption
- Early warning
- Reset output low down to  $V_Q = 1\text{ V}$
- Overtemperature protection
- Reverse polarity proof
- Adjustable reset threshold
- Very low-drop voltage
- Wide temperature range



## Functional Description

This device is an automotive suited voltage regulator with a fixed 5-V output, e.g. in a P-DSO-8-3 package. The maximum operating voltage is 45 V. The output is able to drive 150 mA load. It is short circuit protected and the thermal shutdown switches the output off if the junction temperature is in excess of 150 °C. A reset signal is generated for an output voltage of  $V_Q < 4.65\text{ V}$ . The reset threshold voltage can be decreased by external connection of a voltage divider. The reset delay time can be set by an external capacitor. If the application requires pull-up resistors at the logic outputs (Reset, Sense Out) the TLE 4269 with integrated resistors can be used. It is also possible to supervise the input voltage by using an integrated comparator to give a low voltage warning.

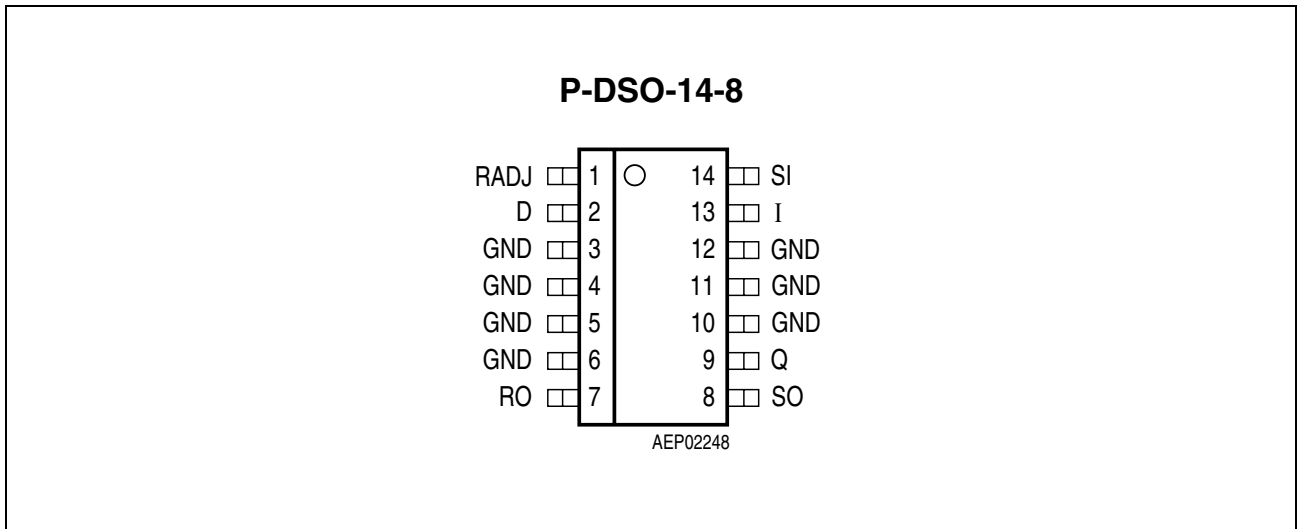
Type	Ordering Code	Package
TLE 4279 G	Q67006-A9225	P-DSO-8-3
TLE 4279 GM	Q67006-A9307	P-DSO-14-8



**Figure 1** Pin Configuration (top view)

**Table 1** Pin Definitions and Functions (TLE 4279 G)

Pin No.	Symbol	Function
1	I	<b>Input;</b> block to GND directly at the IC with a ceramic capacitor
2	SI	<b>Sense input;</b> if not needed connect to Q
3	RADJ	<b>Reset threshold adjust;</b> if not needed connect to ground
4	D	<b>Reset delay;</b> to select the delay time, connect to GND via external capacitor
5	GND	<b>Ground</b>
6	RO	<b>Reset output;</b> open-collector output. Keep open, if not needed
7	SO	<b>Sense output;</b> open-collector output. Keep open, if not needed
8	Q	<b>5-V output;</b> connect to GND with a 10 $\mu$ F capacitor, ESR < 10 $\Omega$



**Figure 2** Pin Configuration (top view)

**Table 2** Pin Definitions and Functions (TLE 4279 GM)

Pin No.	Symbol	Function
1	RADJ	<b>Reset threshold adjust</b> ; if not needed connect to GND
2	D	<b>Reset delay</b> ; connect to GND via external delay capacitor for setting delay time
3, 4, 5, 6	GND	<b>Ground</b>
7	RO	<b>Reset output</b> ; open-collector output. Keep open, if not needed
8	SO	<b>Sense output</b> ; open-collector output. Keep open, if not needed
9	Q	<b>5-V output</b> ; connect to GND via 10 $\mu$ F capacitor, ESR < 10 $\Omega$
10, 11, 12	GND	<b>Ground</b>
13	I	<b>Input</b> ; block to GND directly at the IC by a ceramic capacitor
14	SI	<b>Sense input</b> ; if not needed connect to Q

## Circuit Description

The control amplifier compares a reference voltage, made highly accurate by resistance balancing, with a voltage proportional to the output voltage and drives the base of the series PNP transistor via a buffer. Saturation control as a function of the load current prevents any over-saturation of the power element.

The reset output RO is in high-state if the voltage on the delay capacitor  $C_D$  is greater or equal  $V_{UD}$ . The delay capacitor  $C_D$  is charged with the current  $I_D$  for output voltages greater than the reset threshold  $V_{RT}$ . If the output voltage gets lower than  $V_{RT}$  ('reset condition') a fast discharge of the delay capacitor  $C_D$  sets in and as soon as  $V_D$  gets lower than  $V_{LD}$  the reset output RO is set to low-level.

The time gap for the delay capacitor discharge is the reset reaction time  $t_{RR}$ .

The reset threshold  $V_{RT}$  can be decreased via an external voltage divider connected to the pin RADJ. In this case the reset condition is reached if  $V_Q < V_{RT}$  and  $V_{RADJ} < V_{RAQDJ,TH}$ . Dimensioning the voltage divider (see [Figure 4](#)) according to:

$$V_{THRES} = V_{RADJ,TH} \times (R_{RADJ1} + R_{RADJ2}) / R_{RADJ2}, \quad (1)$$

the reset threshold can be decreased down to 3.5 V. If the reset-adjust-option is not needed the RADJ-pin should be connected to GND causing the reset threshold to go to its default value (typ. 4.65 V).

A built in comparator compares the signal of the pin SI, normally fed by a voltage divider from the input voltage, with the reference and gives an early warning on the pin SO. It is also possible to supervise another voltage e.g. of a second regulator, or to build a watchdog circuit with few external components.

## Application Description

The input capacitor  $C_I$  is necessary for compensating line influences. Using a resistor of approx. 1  $\Omega$  in series with  $C_I$ , the oscillating circuit consisting of input inductivity and input capacitance can be damped. The output capacitor  $C_O$  is necessary for the stability of the regulating circuit. Stability is guaranteed at values  $\geq 10 \mu\text{F}$  and an ESR  $\leq 10 \Omega$  within the operating temperature range. Both reset output and sense output are open collector outputs and have to be connected to 5 V output via external pull-up resistors  $\geq 10 \text{ k}\Omega$ . For small tolerances of the reset delay the spread of the capacitance of the delay capacitor and its temperature coefficient should be noted.

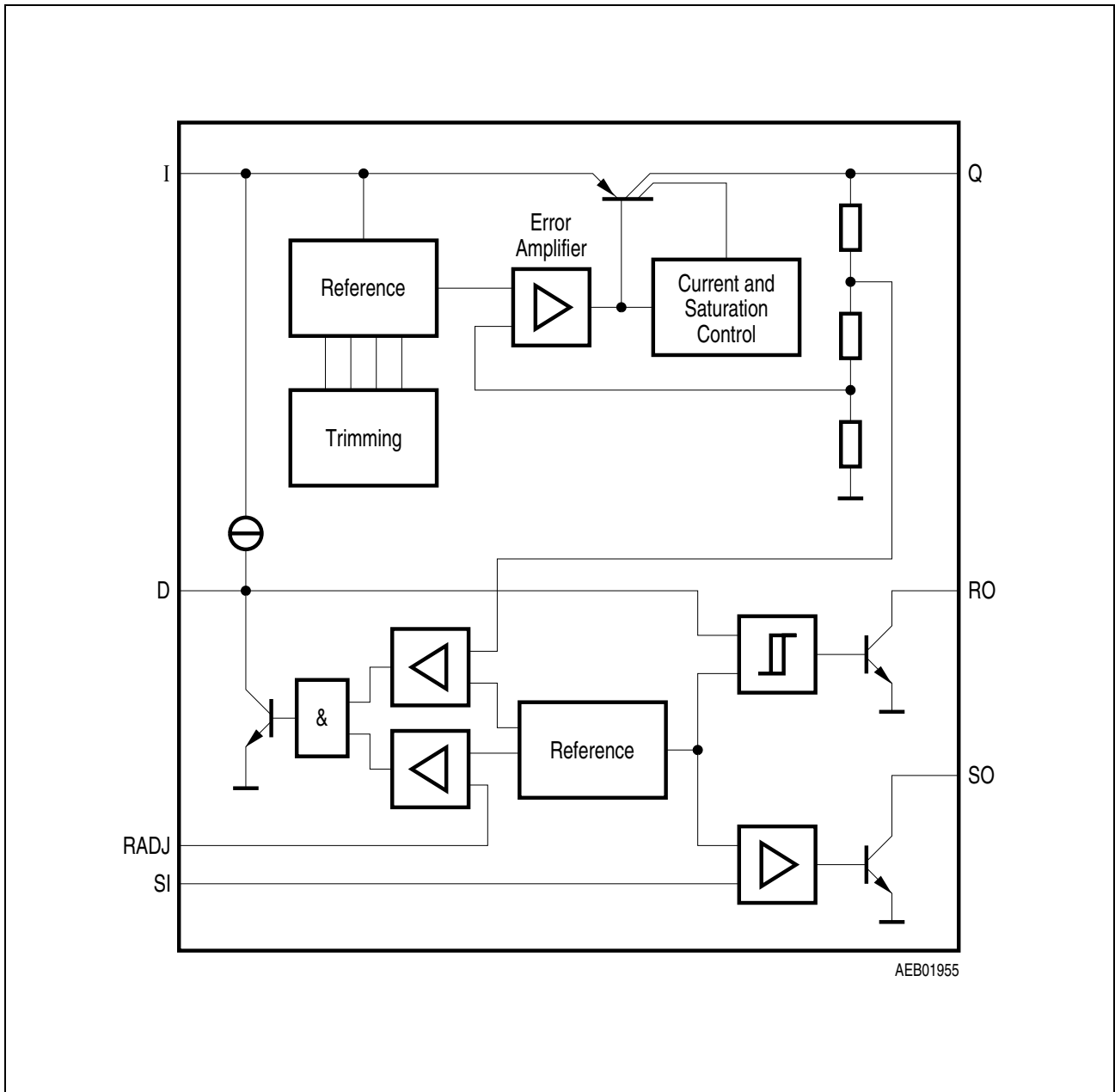


Figure 3 Block Diagram

**Table 3 Absolute Maximum Ratings**

$T_j = -40$  to  $150$  °C

Parameter	Symbol	Limit Values		Unit	Notes
		Min.	Max.		
<b>Input</b>					
Input voltage	$V_I$	-40	45	V	–
Input current	$I_I$	–	–	–	internal limited
<b>Sense Input</b>					
Input voltage	$V_{SI}$	-40	45	V	–
Input current	$I_{SI}$	1	1	mA	–
<b>Reset Threshold</b>					
Voltage	$V_{RADJ}$	-40	7	V	–
Current	$I_{RADJ}$	-10	10	mA	–
<b>Reset Delay</b>					
Voltage	$V_D$	-0.3	7	V	–
Current	$I_D$	–	–	–	internal limited
<b>Ground</b>					
Current	$I_{GND}$	50	–	mA	–
<b>Reset Output</b>					
Voltage	$V_R$	-0.3	7	V	–
Current	$I_R$	–	–	–	internal limited
<b>Sense Output</b>					
Voltage	$V_{SO}$	-0.3	7	V	–
Current	$I_{SO}$	–	–	–	internal limited
<b>5-V Output</b>					
Output voltage	$V_Q$	-0.5	7	V	–
Output current	$I_Q$	-10	–	mA	–
<b>Temperature</b>					
Junction temperature	$T_j$	–	150	°C	–
Storage temperature	$T_{Stg}$	-50	150	°C	–

**Table 3 Absolute Maximum Ratings (cont'd)**

$T_j = -40$  to  $150$  °C

Parameter	Symbol	Limit Values		Unit	Notes
		Min.	Max.		
<b>Operating Range</b>					
Input voltage	$V_I$	–	45	V	–
Junction temperature	$T_j$	-40	150	°C	–
<b>Thermal Data</b>					
Junction-ambient	$R_{thja}$	–	200	K/W	P-DSO-8-3
		–	70	K/W	P-DSO-14-8
Junction-pin	$R_{thjp}$	–	30	K/W	P-DSO-14-8 <sup>1)</sup>

1) measured to Pin 4

**Table 4 Characteristics**
 $V_I = 13.5 \text{ V}; T_j = -40 \text{ }^\circ\text{C} < T_j < 125 \text{ }^\circ\text{C}$ 

Parameter	Symbol	Limit Values			Unit	Measuring Condition
		Min.	Typ.	Max.		
Output voltage	$V_Q$	4.90	5.00	5.10	V	$1 \text{ mA} \leq I_Q \leq 100 \text{ mA}$ $6 \text{ V} \leq V_I \leq 16 \text{ V}$
Current limit	$I_Q$	150	200	500	mA	–
Current consumption; $I_q = I_I - I_Q$	$I_q$	–	150	300	$\mu\text{A}$	$I_Q \leq 1 \text{ mA}, T_j < 85 \text{ }^\circ\text{C}$
Current consumption; $I_q = I_I - I_Q$	$I_q$	–	250	700	$\mu\text{A}$	$I_Q = 10 \text{ mA}$
Current consumption; $I_q = I_I - I_Q$	$I_q$	–	2	8	mA	$I_Q = 50 \text{ mA}$
Drop voltage	$V_{dr}$	–	0.25	0.5	V	$I_Q = 100 \text{ mA}^1)$
Load regulation	$\Delta V_Q$	–	10	30	mV	$I_Q = 5 \text{ mA to } 100 \text{ mA}$
Line regulation	$\Delta V_Q$	–	10	40	mV	$V_I = 6 \text{ V to } 26 \text{ V}$ $I_Q = 1 \text{ mA}$

**Reset Generator**

Switching threshold	$V_{RT}$	4.50	4.65	4.80	V	–
Reset adjust switching voltage	$V_{RADJ,TH}$	1.26	1.35	1.44	V	$V_Q > 3.5 \text{ V}$
Reset low voltage	$V_{RO,SAT}$	–	0.1	0.4	V	$R_{\text{extern}} = 20 \text{ k}\Omega$
Upper delay switching threshold	$V_{UD}$	1.4	1.8	2.2	V	–
Lower delay switching threshold	$V_{LD}$	0.3	0.45	0.60	V	–
Reset delay low voltage	$V_{D,SAT}$	–	–	0.1	V	$V_Q < V_{RT}$
Charge current	$I_D$	3.0	6.5	9.5	$\mu\text{A}$	$V_D = 1 \text{ V}$
Delay time L $\rightarrow$ H	$t_d$	17	28	–	ms	$C_D = 100 \text{ nF}$
Delay time H $\rightarrow$ L	$t_t$	–	1	–	$\mu\text{s}$	$C_D = 100 \text{ nF}$

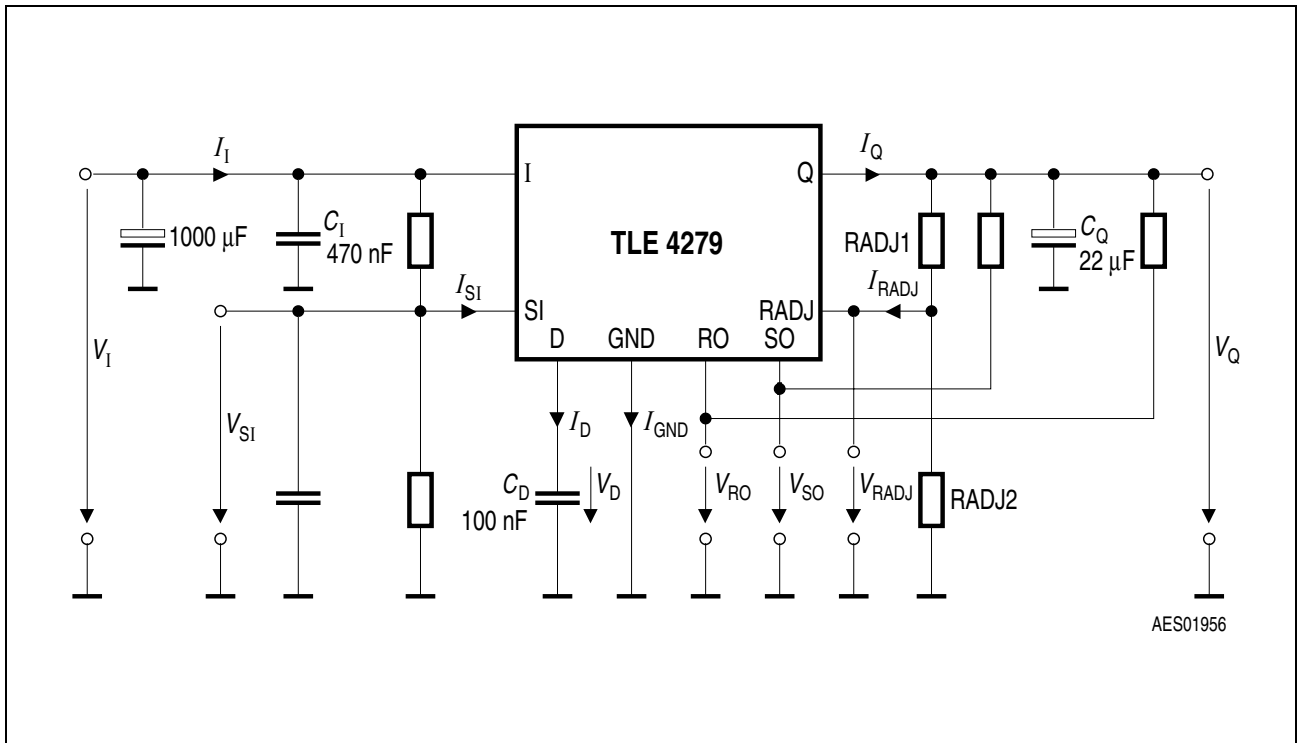


**Table 4 Characteristics (cont'd)**

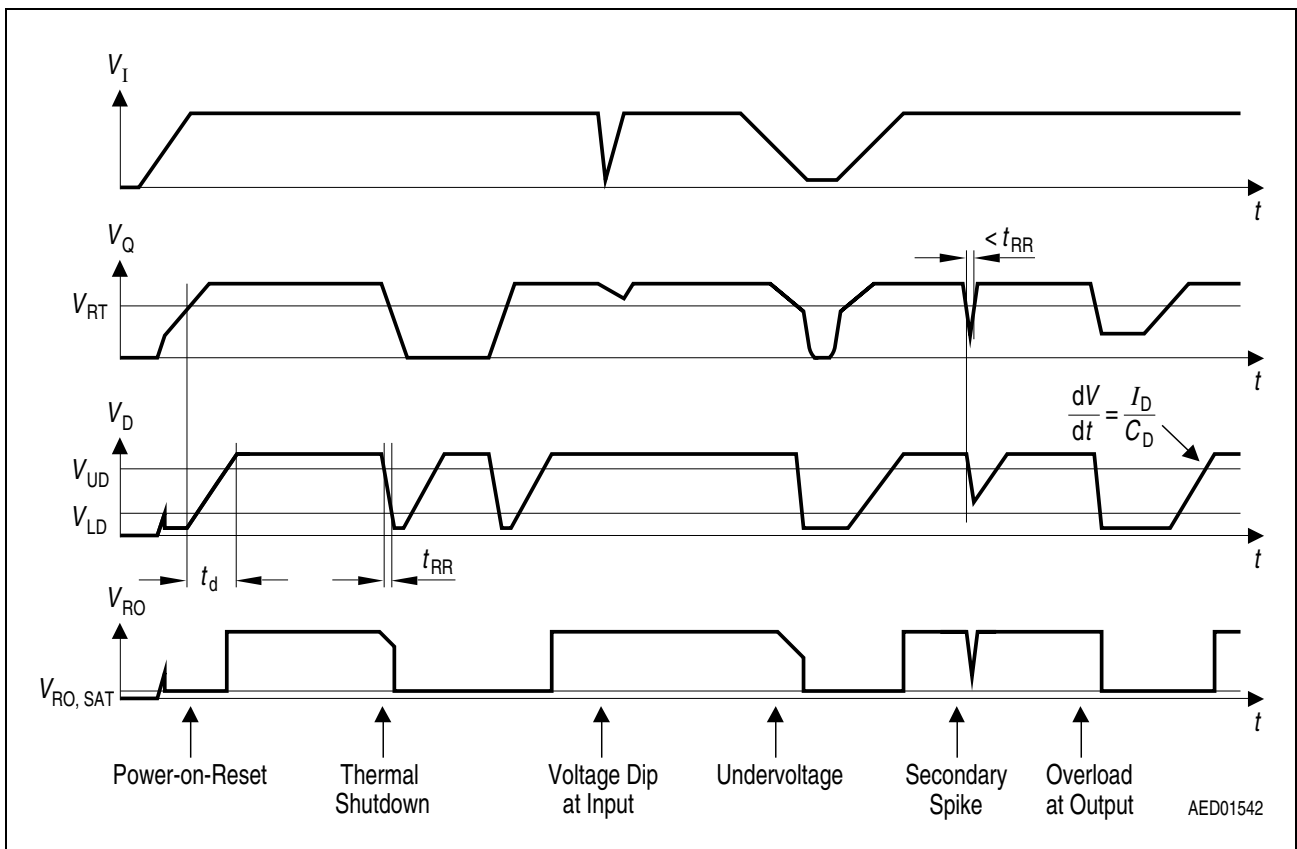
$V_I = 13.5 \text{ V}; T_j = -40 \text{ }^\circ\text{C} < T_j < 125 \text{ }^\circ\text{C}$

Parameter	Symbol	Limit Values			Unit	Measuring Condition
		Min.	Typ.	Max.		
<b>Input Voltage Sense</b>						
Sense threshold high	$V_{SI, high}$	1.24	1.31	1.38	V	–
Sense threshold low	$V_{SI, low}$	1.16	1.20	1.28	V	–
Sense output low voltage	$V_{SO, low}$	–	0.1	0.4	V	$V_{SI} < 1.20 \text{ V};$ $V_Q > 3 \text{ V};$ $R_{\text{extern}} = 20 \text{ k}\Omega$
Sense input current	$I_{SI}$	-1	0.1	1	$\mu\text{A}$	–

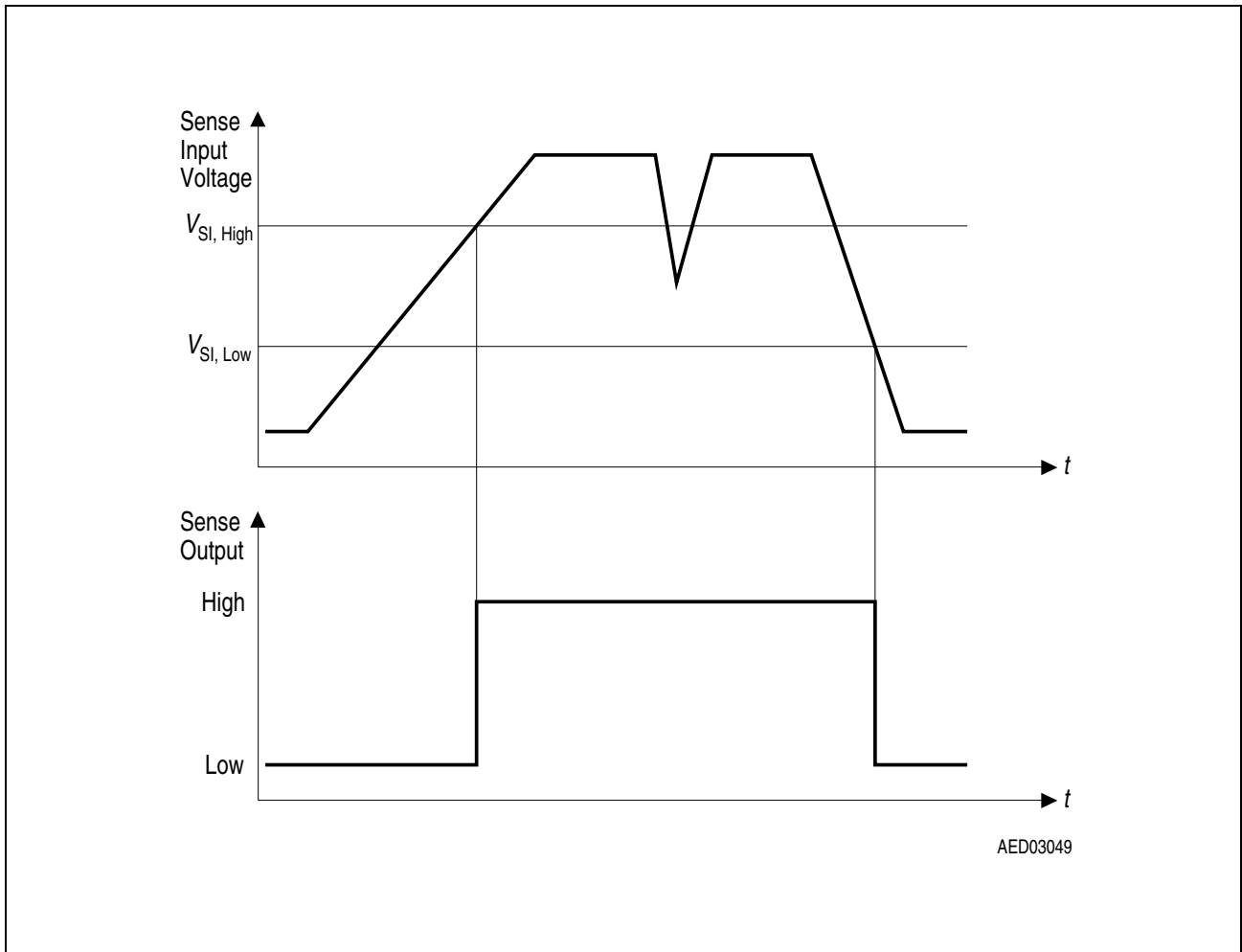
1) Drop voltage =  $V_I - V_Q$  (measured when the output voltage has dropped 100 mV from the nominal value obtained at 13.5 V input.)



**Figure 4 Measuring Circuit**

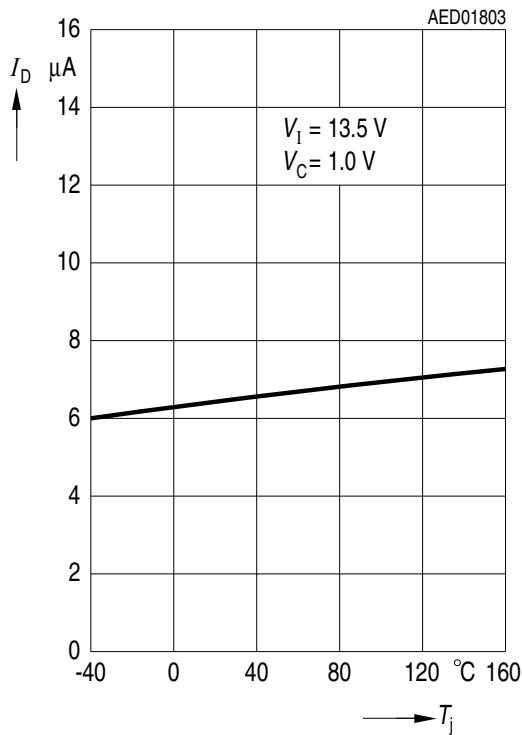


**Figure 5 Reset Timing Diagram**

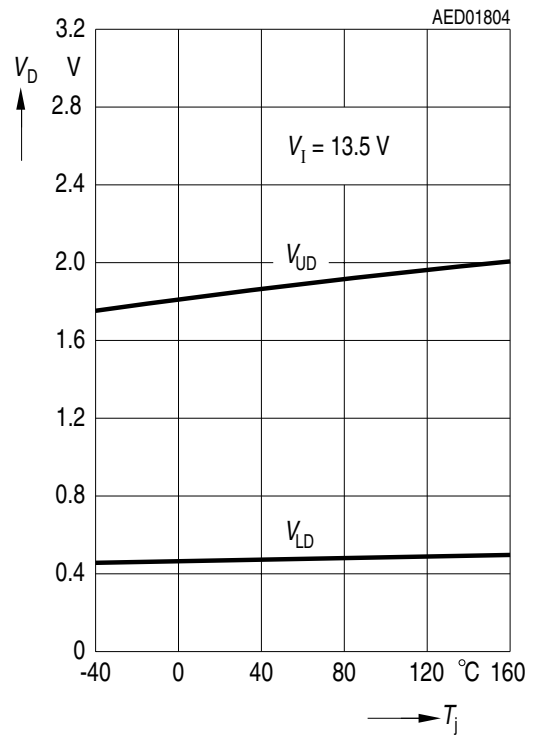


**Figure 6** Sense Input Timing Diagram

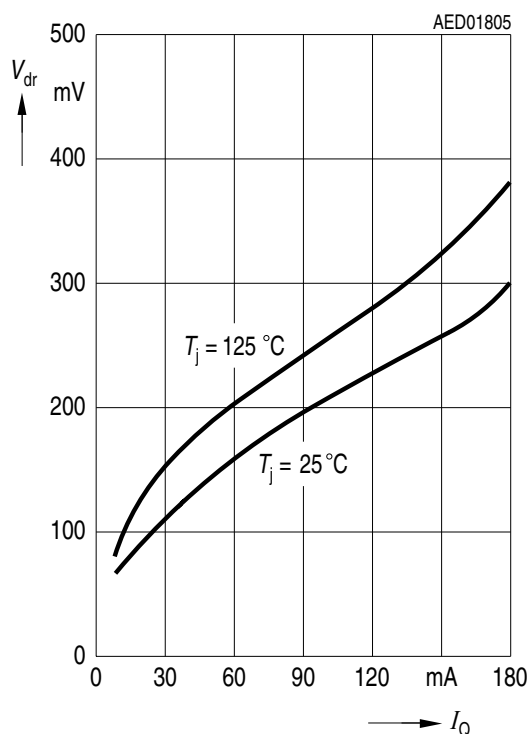
**Charge Current  $I_D$  versus Temperature  $T_i$**



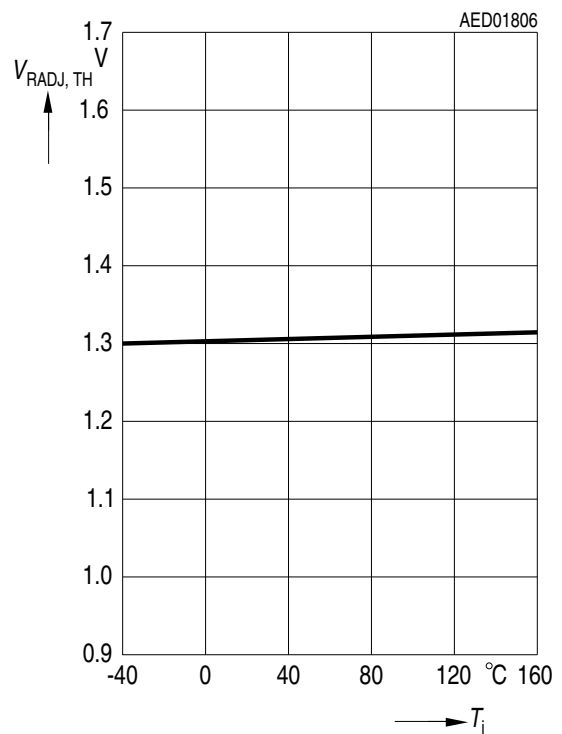
**Switching Voltage  $V_{UD}$  and  $V_{LD}$  versus Temperature  $T_i$**



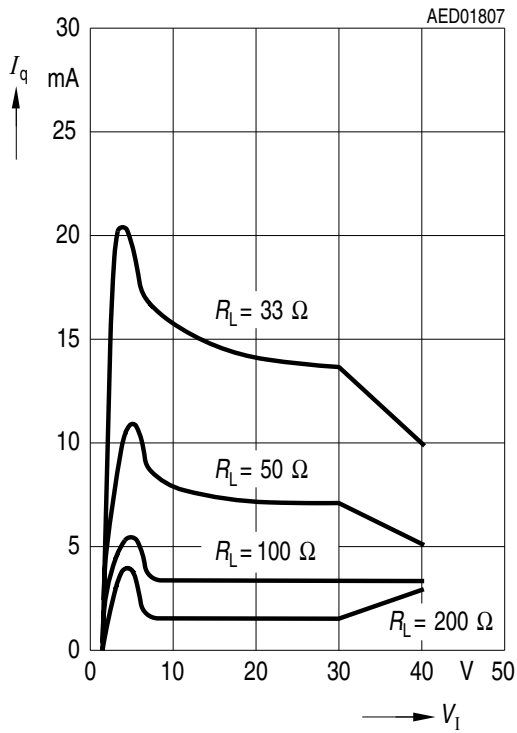
**Drop Voltage  $V_{dr}$  versus Output Current  $I_Q$**



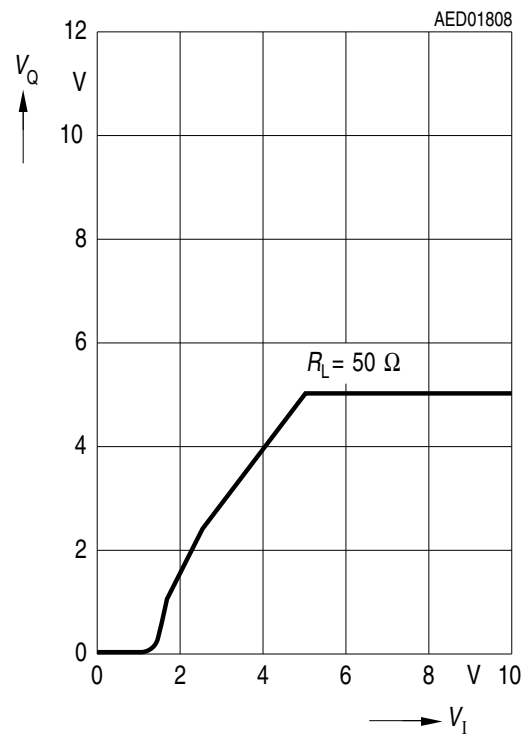
**Reset Adjust Switching Threshold  $V_{RADJ,TH}$  versus Temperature  $T_i$**



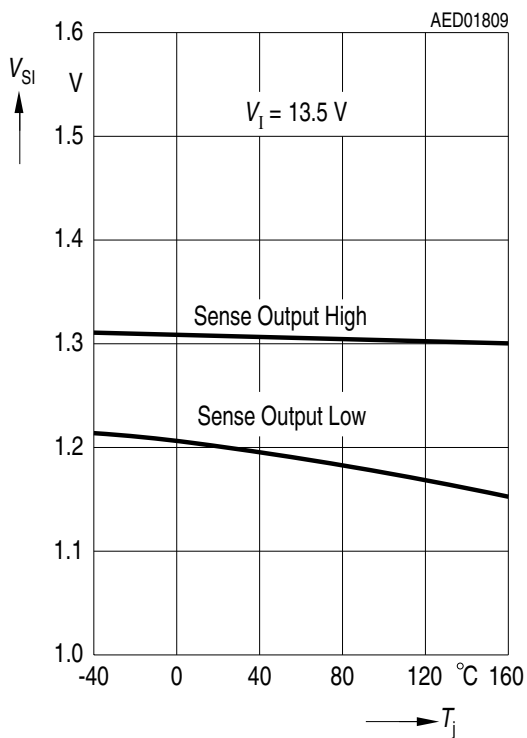
**Current Consumption  $I_Q$  versus Input Voltage  $V_I$**



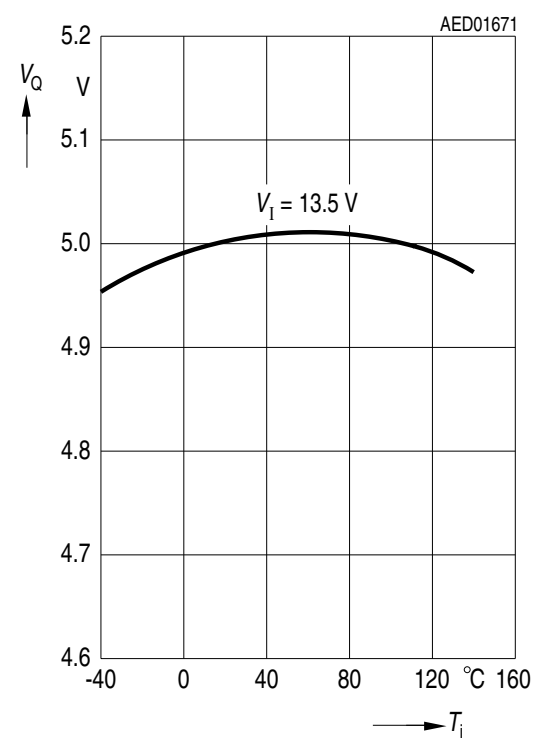
**Output Voltage  $V_Q$  versus Input Voltage  $V_I$**



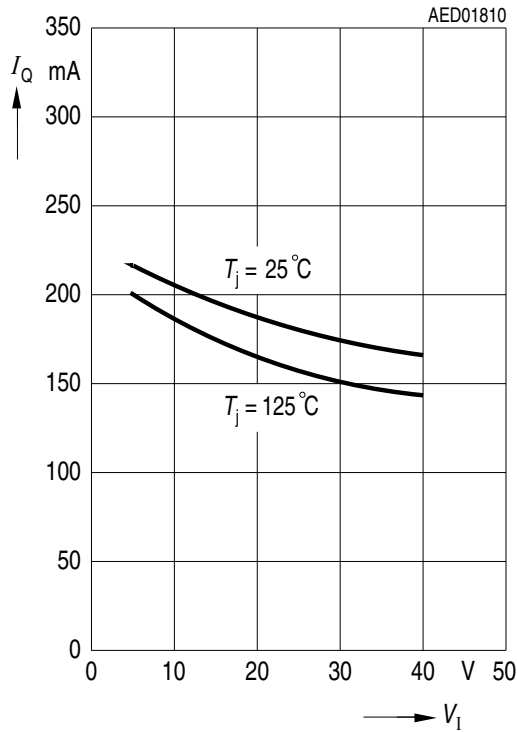
**Sense Threshold  $V_{SI}$  versus Temperature  $T_j$**



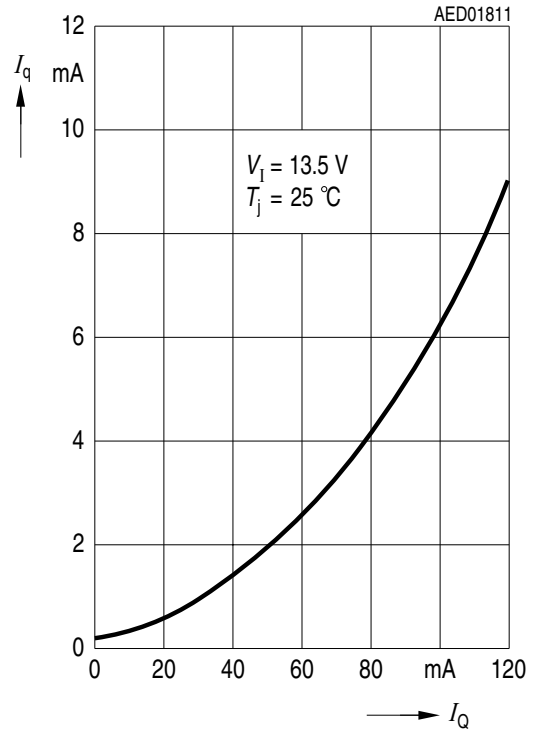
**Output Voltage  $V_Q$  versus Temperature  $T_j$**



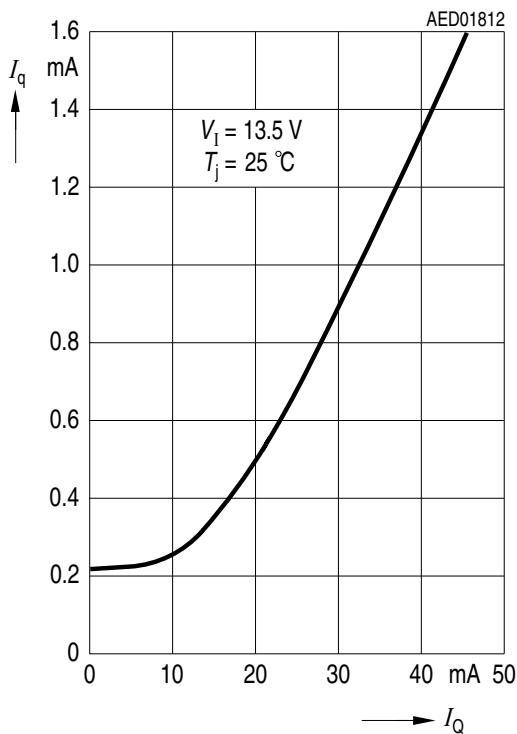
**Output Current  $I_Q$  versus Input Voltage  $V_I$**



**Current Consumption  $I_q$  versus Output Current  $I_Q$**



**Current Consumption  $I_q$  versus Output Current  $I_Q$**



Package Outlines

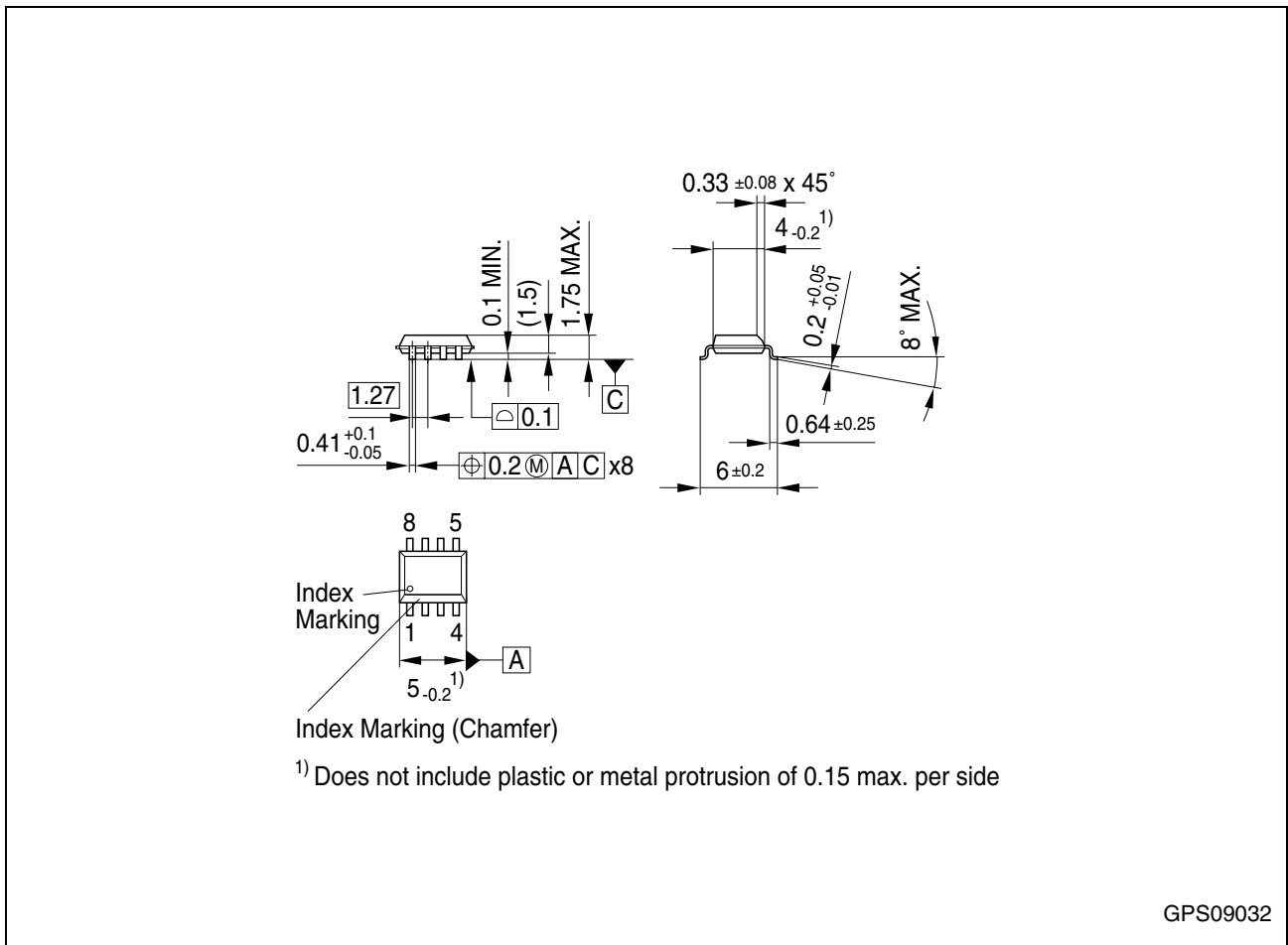
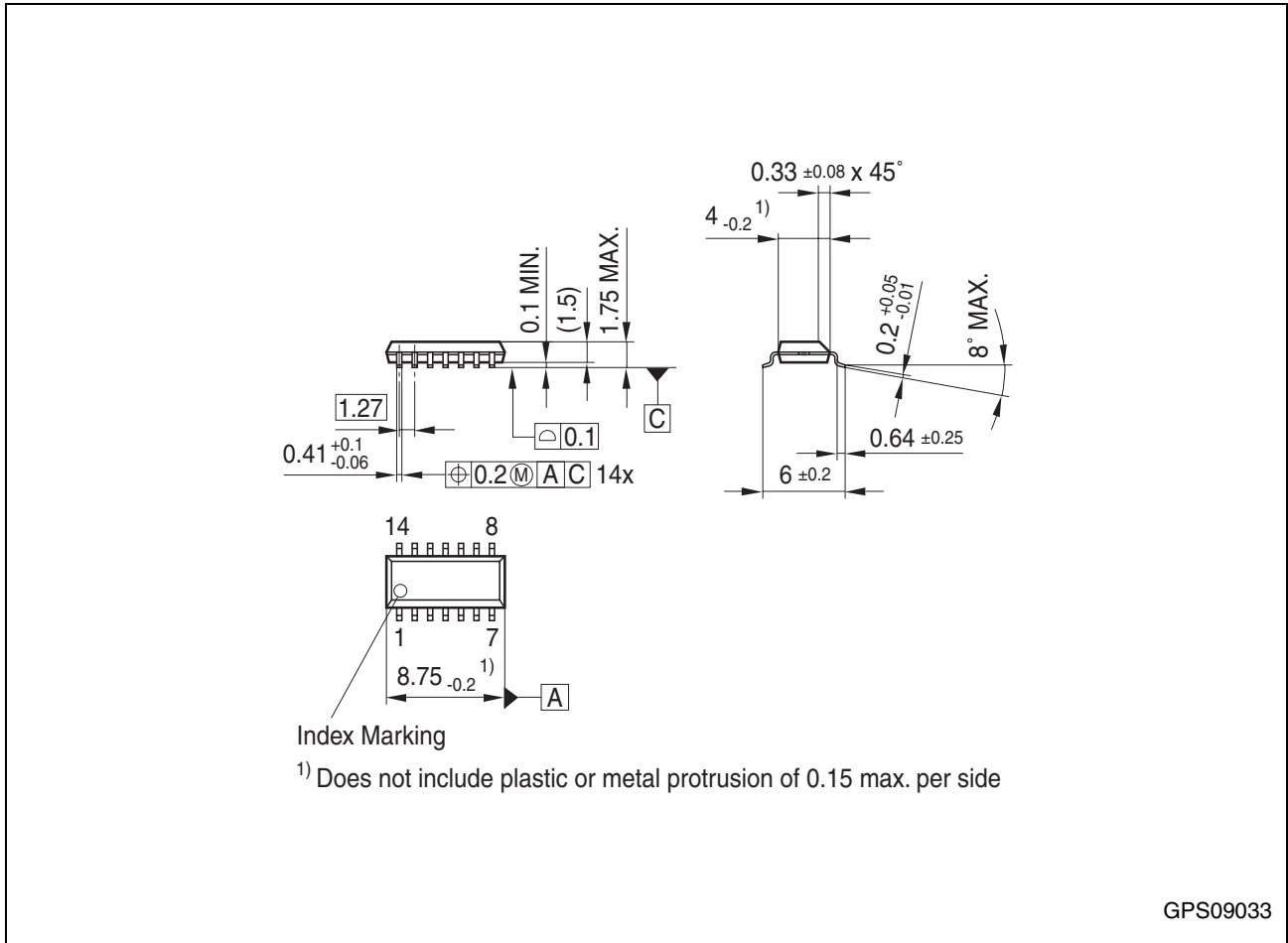


Figure 7 P-DSO-8-3 (Plastic Dual Small Outline)

You can find all of our packages, sorts of packing and others in our Infineon Internet Page "Products": <http://www.infineon.com/products>.

SMD = Surface Mounted Device

Dimensions in mm



**Figure 8** P-DSO-14-8 (Plastic Dual Small Outline)

You can find all of our packages, sorts of packing and others in our Infineon Internet Page "Products": <http://www.infineon.com/products>.

SMD = Surface Mounted Device

Dimensions in mm



**Edition 2004-01-01**

**Published by Infineon Technologies AG,  
St.-Martin-Strasse 53,  
81669 München, Germany**

**© Infineon Technologies AG 2004.  
All Rights Reserved.**

**Attention please!**

The information herein is given to describe certain components and shall not be considered as a guarantee of characteristics.

Terms of delivery and rights to technical change reserved.

We hereby disclaim any and all warranties, including but not limited to warranties of non-infringement, regarding circuits, descriptions and charts stated herein.

**Information**

For further information on technology, delivery terms and conditions and prices please contact your nearest Infineon Technologies Office ([www.infineon.com](http://www.infineon.com)).

**Warnings**

Due to technical requirements components may contain dangerous substances. For information on the types in question please contact your nearest Infineon Technologies Office.

Infineon Technologies Components may only be used in life-support devices or systems with the express written approval of Infineon Technologies, if a failure of such components can reasonably be expected to cause the failure of that life-support device or system, or to affect the safety or effectiveness of that device or system. Life support devices or systems are intended to be implanted in the human body, or to support and/or maintain and sustain and/or protect human life. If they fail, it is reasonable to assume that the health of the user or other persons may be endangered.