

Digital LCD Colour Television
Télévision Couleur LCD Digital
Digitales LCD-Farb-TV-Gerät
Televisione a Colori LCD Digitale

L32H01E A

HDMITM
HIGH DEFINITION MULTIMEDIA INTERFACE

HITACHI
Inspire the Next

Instructions for use **GB**

Notice d'utilisation **F**

Bedienungsanleitung **D**

Istruzioni per l'uso **I**



HITACHI

Contents

Safety Precautions	3	Equalizer	22
Features	6	Balance	23
Accessories	6	Headphone	23
LCD TV Front View	7	<i>volume</i>	23
Rear View and Peripheral Connections	7	<i>sound mode</i>	23
Remote Control Buttons	8	<i>balance</i>	23
Installation Of The TFT TV To The Wall	9	Sound Mode	23
Preparation	11	AVL	23
Before Switching On Your TV	11	Effect	23
Power Connection	11	Dynamic Bass	23
Connections To The Aerial Input Socket	11	Subwoofer	23
Inserting Batteries In The Remote Control		3DS	23
Handset	11	Feature Menu	23
Handling the Remote Control	11	PIP	23
Operating Range for the Remote Control ...	11	<i>PIP ON-OFF</i>	24
Switching The TV ON/OFF	12	<i>PIP Picture</i>	24
To switch the TV on:	12	<i>PIP Position</i>	24
To switch the TV off:	12	<i>PIP Source</i>	24
Navigating the Menu System	12	<i>PIP SWAP</i>	24
Initial Settings	12	PAP	24
Everyday Operation	13	<i>PAP ON-OFF</i>	24
Information Banner	13	<i>PAP Picture</i>	24
ELECTRONIC PROGRAMME GUIDE (EPG) ...	13	<i>PAP Source</i>	24
Displaying The Subtitles	14	<i>PAP SWAP</i>	24
Teletext	14	Sleep Timer	24
DTV Menu System	14	Child Lock	24
Channel List	14	Language	24
Navigating the whole channel list	15	AV-2 Out	24
Moving the channels in the channel list	15	PC Audio In	25
Deleting the channels in the channel list	15	Blue Background	25
Renaming channels	15	Menu Background	25
Adding locks to channels	16	Menu Timeout	25
Setting Favourites	16	Teletext Language	25
<i>How To Add A Channel To A Favourite List:</i>	16	Default Zoom	25
<i>On Screen Help Pressing INFO Button</i>	16	Install Menu	25
Installation	17	Program Table	25
Configuration	18	<i>Name</i>	25
Timers	20	<i>Insert</i>	25
TV Setup	21	<i>Delete</i>	25
Common Interface	21	<i>APS (Auto Programming System)</i>	26
Analogue TV Menu System	22	A.P.S. (Auto Programming System)	
Picture Menu	22	Country	26
Mode	22	Program	26
Contrast/Brightness/Sharpness/Colour/		Band	26
Hue	22	Channel	26
Colour Temp	22	Colour System	26
Noise Reduction	22	Sound System	26
Film Mode	22	Fine Tune	26
3D Comb	22	Search	26
Picture Zoom	22	Store	26
Reset	22	Install menu in AV modes	26
Sound Menu	22	<i>Colour System</i>	27
Volume	22	<i>VCR</i>	27
		Store	27
		Source menu	27

PC Mode	27	Tips	31
Installation	27	Care Of The Screen	31
Menu System in PC mode	27	Poor Picture	31
Sound Menu/Feature Menu	27	No Picture	31
PC Picture Menu	27	Sound	31
PC POSITION Menu	27	Remote Control	31
Autoposition	27	Peripheral Equipment Connections	32
H (Horizontal) Position	28	Aerial Connection	32
V (Vertical) Position	28	Specifications	33
Phase	28	S-input connector pin specifications	35
Dot Clock	28	HDMI connector pin specifications	35
Sound in PC mode	28	SCART connector pin specifications	35
Other Features	28	Signal Input	35
TV Status	28	PC RGB Terminal (D-sub 15-pin connector)	35
Mute Indicator	28	Appendix A: PC Input Typical Display	
PIP and PAP Modes	28	Modes	36
AV Modes	28	Appendix B: AV and HDMI Signal	
Zoom Modes	29	Compatibility	37
Auto	29	Appendix C: Main and PIP-PAP Picture	
Zoom	29	Combinations	38
Cinema	29	Addendum to the instruction book.	38
16:9 Zoom	29	UK Guarantee	39
Subtitle	29		
4:3	29		
14:9 Zoom	29		
Panoramic	29		
Freeze Picture	29		
Teletext	30		
Connect Peripheral Equipment	30		
High Definition	30		
Via The Scart	30		
Via Aerial Input	30		
Decoder	30		
Connect a decoder with an aerial socket to the TV	30		
Connect a decoder without an aerial socket to the TV	30		
TV And Video Recorder	30		
Playback NTSC	31		
Camera And Camcorder	31		
To Connect To AV Input	31		
To Connect To S-VHS Input	31		
Connect The Decoder To The Video Recorder	31		
Connecting Headphones (optional)	31		
Audio Lineout	31		
Connecting Subwoofer	31		

Safety Precautions

Please read the following recommended safety precautions carefully for your safety.

IMPORTANT SAFETY INFORMATION ON OPERATING YOUR TV

Do's and Don'ts



DO's

This Television has been designed and manufactured to meet international safety standards, but like any electrical equipment, care must be taken if you are to obtain the best results and safety is to be assured.

DO read the operating instructions before you attempt to use the equipment.

DO consult your dealer if you are in any doubt about installation, operation or safety of your equipment.

DO be careful with glass panels or doors on equipment.

This TV is supplied with a fitted mains plug. This plug must not be cut off as it may contain a special radio interference filter, the removal of which could lead to impaired performance. If you wish to extend the lead, obtain an appropriate safety approved extension lead or consult your dealer. Observe the manufacturers instructions when connecting extension leads to the TV. Check the fuse rating on the new plug, this should be fitted with a 5 Amp fuse which conforms to either ASTA or BSI (BS1 362) approvals, these are easily identifiable by either the  or  symbols. If you are in any doubt about the installation of an extension lead, please consult a competent electrician.

DON'Ts

DON'T continue to operate the equipment if you are in any doubt about it working normally, or if it is damaged in any way switch off, withdraw the mains plug and consult your dealer.

DON'T place water filled vessels on top of T.V. cabinets.

DON'T remove any fixed cover as this may expose dangerous voltages.

DON'T leave equipment switched on when it is unattended unless it is specifically stated that it is designed for unattended operation or has a stand-by mode. Switch off using the switch on the equipment and make sure your family know how to do this. Special arrangements may need to be made for infirm or handicapped people.

DON'T use equipment such as personal stereos or radios so that you are distracted from the requirements of traffic safety. It is illegal to watch television whilst driving.

DON'T obstruct the ventilation of the equipment, for example with curtains or soft furnishings. Overheating will cause damage and shorten the life of the equipment.

DON'T use makeshift stands and NEVER fix legs or stands to the TV with any screws other than those provided - to ensure complete safety always use the manufacturers approved stand with the fixings provided.

DON'T allow electrical equipment to be exposed to rain or moisture.

ABOVE ALL

- **NEVER let anyone, especially children push anything into holes, slots or any other opening in the case - this could result in a fatal electric shock.**
- **NEVER guess or take chances with electrical equipment of any kind - it is better to be safe than sorry!**

PE Connection to mains

Be sure to ground the connection properly. Connect the ground terminal of TV with the ground terminal provided at the power outlet using the enclosed power cord. If the provided plug does not fit your outlet, consult an electrician for replacement of the obsolete outlet.



Surely connect the ground wire.

1. Power Source

The TV set should be operated only from a 220-240 V AC, 50 Hz outlet. Ensure that you select the correct voltage setting for your convenience.

2. Power Cord

Do not place the set, a piece of furniture, etc. on the power cord (mains lead) or pinch the cord. Handle the power cord by the plug. Do not pull out the plug by tugging the cord and never touch the power cord when your hands are wet as this could cause a short circuit or electric shock. Never make a knot in the cord or tie it with other cords. The power cords should be placed in such a way that they are not likely to be stepped on. A damaged power cord can cause fire or give you an electric shock. When it is damaged and needs to be changed, it should be done by qualified personnel.

3. Moisture and Water

Do not use this equipment in a humid and damp place (avoid the bathroom, the sink in the kitchen, and near the washing machine). Do not expose this equipment to rain or water, as this may be dangerous and do not place objects filled with liquids, such as flower vases, on top. Avoid from dripping or splashing.

If any solid object or liquid falls into the cabinet, unplug the TV and have it checked by qualified personnel before operating it any further.

4. Cleaning

Before cleaning, unplug the TV set from the wall outlet. Do not use liquid or aerosol cleaners. Use soft and dry cloth.

5. Ventilation

The slots and openings on the TV set are intended for ventilation and to ensure reliable operation. To prevent overheating, these openings must not be blocked or covered in anyway.

6. Heat and Flames

The set should not be placed near to naked flames and sources of intense heat, such as an electric heater. Ensure that no naked flame sources, such as lighted candles, are placed on top of the TV. Batteries shall not be exposed to excessive heat such as sunshine, fire or the like.

7. Lightning

In case of storm and lightning or when going on holiday, disconnect the power cord from the wall outlet.

8. Replacement Parts

When replacement parts are required, be sure the service technician has used replacement parts which are specified by the manufacturer or have the same specifications as the original one. Unauthorized sub-

stitutions may result in fire, electrical shock, or other hazards.

9. Servicing

Please refer all servicing to qualified personnel. Do not remove the cover yourself as this may result in an electric shock.

10. Waste Disposal

Instructions for waste disposal:

- Packaging and packaging aids are recyclable and should principally be recycled. Packaging materials, such as foil bag, must be kept away from children.
- Battery, including those which are heavy metal-free, should not be disposed of with household waste. Please dispose of used battery in an environmentally sound manner. Find out about the legal regulations which apply in your area.
- Cold cathode fluorescent lamp in LCD PANEL contains a small amount of mercury; please follow local ordinances or regulations for disposal.

Information for users applicable in European Union countries



This symbol on the product or on its packaging means that your electrical and electronic equipment should be disposed at the end of life separately from your household wastes. There are separate collection systems for recycling in EU.

For more information, please contact the local authority or the dealer where you purchased the product.

11. Disconnect Device

The mains plug is used to disconnect TV set from the mains and therefore it shall remain readily operable.

12. Excessive sound pressure from earphones and headphones can cause hearing loss.

13. To prevent injury, this device must be securely attached to the wall in accordance with the installation instructions when mounted to the wall (if the option is available).

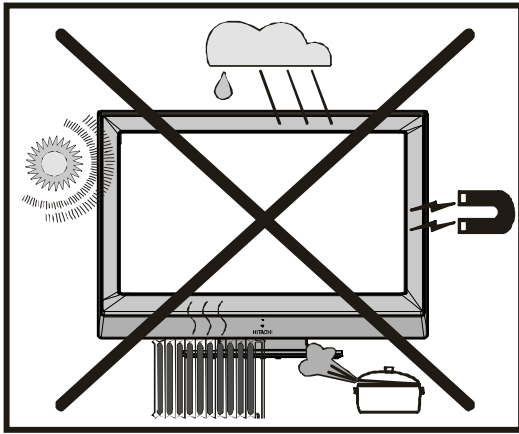

14. Connection to a television distribution system (Cable TV etc.) from tuner:

Apparatus connected to the protective earthing of the building installation through the mains connection or through other apparatus with a connection to protective earthing - and to a television distribution system using coaxial cable, may in some circumstances create a fire hazard.

To ground the antenna system properly, be sure that the cable grounding is connected with the building's grounding system. Note that the connection should follow IEC 60364-7-707 and IEC 60364-5-548 standards which require that the grounding should be as close as possible to the cable connection.

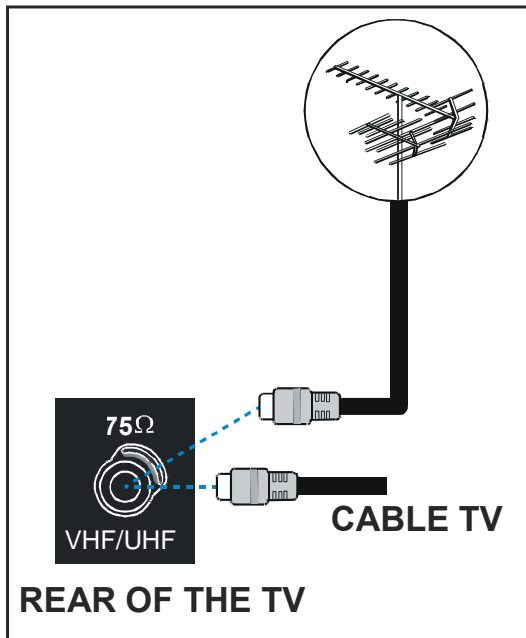

Features

- Remote controlled colour LCD TV.
- Fully integrated Digital TV (DVB-T)
- 100 programmes from VHF, UHF bands or cable channels can be preset.
- It can tune cable channels.
- Controlling the TV is very easy by its menu driven system.
- It has 2 Scart sockets for external devices (such as video, video games, audio set, etc.)
- Stereo sound system (German+Nicam).
- Full function Teletext (1000 pages).
- Fastext, TOP text.
- Headphone connection.
- A.P.S. (Automatic Programming System).
- All programmes can be named.
- Forward or backward automatic tuning.
- Sleep timer.
- Child Lock.
- Automatic sound mute when no transmission.
- NTSC Playback.
- AV in and S-VIDEO in are available.
- It has two HDMI connectors for Digital Video and Audio. This connection is also designed to accept High Definition signals.
- AVL (Automatic Volume Limiting)
- When no valid signal is detected, after 5 minutes the TV switches itself automatically to stand-by mode.
- PLL (Frequency Search)
- PC Input
- Plug&Play for Windows 9X, ME, Vista, 2000, XP.
- Audio Line Out

Accessories

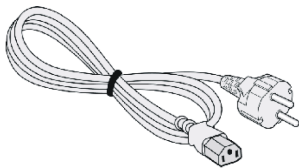

EU Plug



15 Pin D-SUB VGA Cable.



Phono L+R to 3.5mm Jack Audio Cable.



Remote Controller
CLE-984

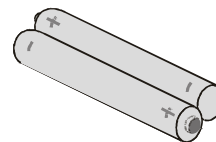

Batteries
2 X AA



Instruction Book

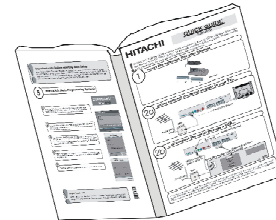

Quick Guide

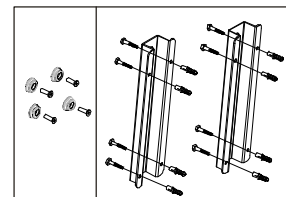

Wall Mount Kit

LCD TV Front View

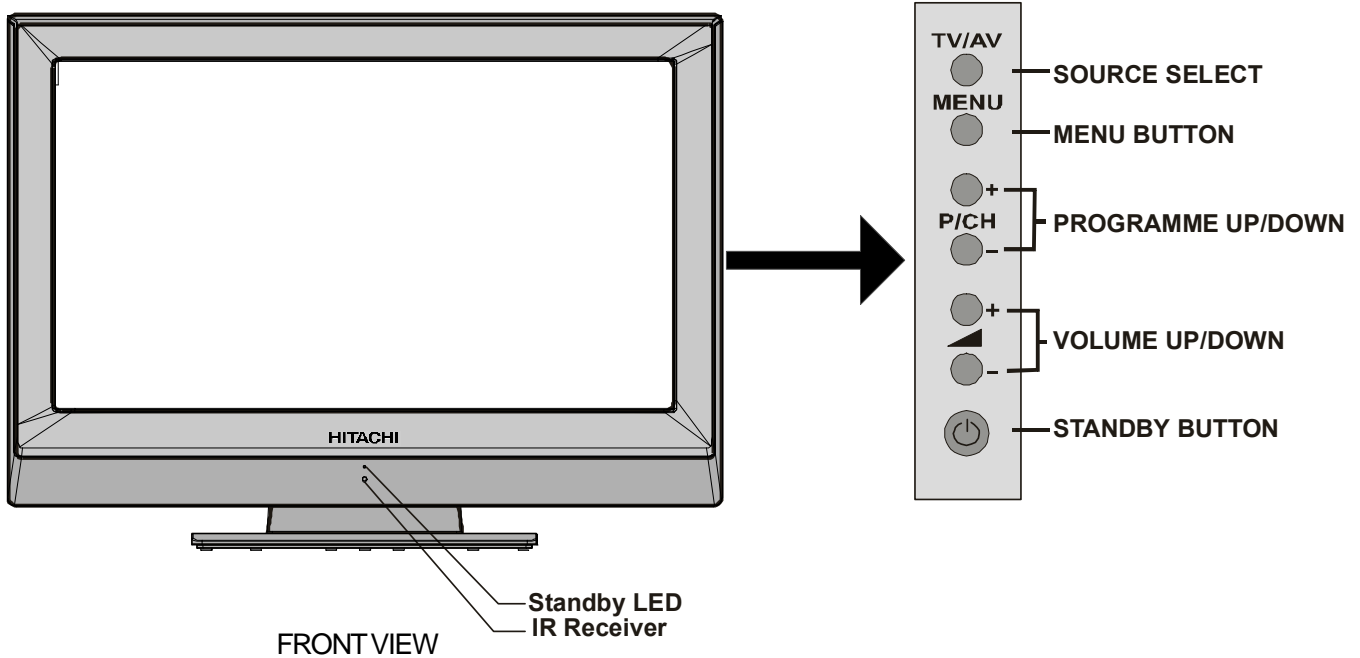

Rear View and Peripheral Connections

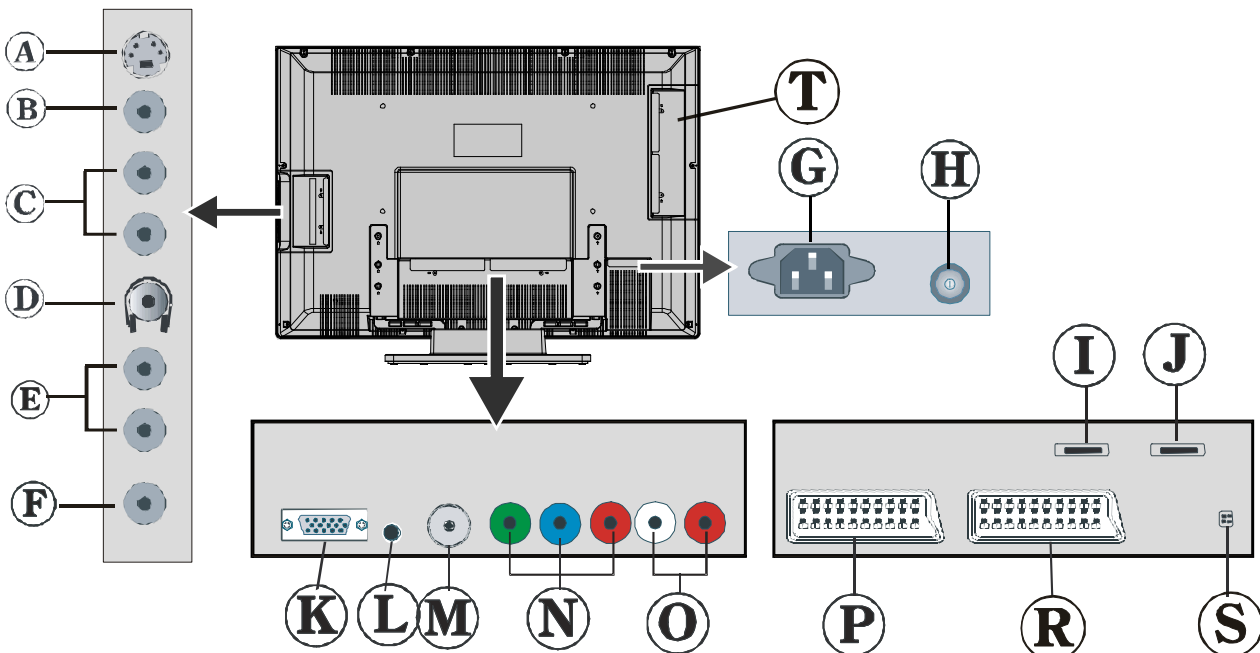

A S-VIDEO Input

B Video Input

C Audio Inputs

D Headphone

E Audio Line Outs

F Subwoofer Output

G Power Cord Input

H Power On/Off Switch

I HDMI Input 2

J HDMI Input 1

K PC Input

L PC Audio Input

M RF

N Component Video Inputs (YPBPR)

O Component Audio Inputs

P SCART 1

R SCART 2

S For Service Use Only

T CI Slot

Note: Because FAV CVBS and SVHS Y are connected parallelly, the picture may blend if the two peripherals are used at the same time. Likewise, because SVHS C and SCART II R are connected parallelly, the picture may blend if the two peripherals are used at the same time. Thus these two are not to be used at the same time.

Remote Control Buttons

- ① = Stand by On/Off
- ② = Info
- ③ **DVD** = Select DVD
- ④ **TV/DTT** = Selector button for Digital/Analogue mode
- ⑤ = Hold in teletext mode, Freeze picture
- ⑥ = Volume Up/ Down
- ⑦ = Mute On/Off
- ⑧ **RED** (Only use in Teletext mode)
- ⑨ **GREEN** (subtitle on/off in DTT mode)
- ⑩ = Teletext On-Off
- ⑪ = Update
- ⑫ = Menu On/Off
- ⑬ = Cursor buttons
- ⑭ **FUNCTION** = No function
- ⑮ = Equalizer Sound Mode
- ⑯ = Aspect ratio
- ⑰ = No Function
- ⑱ Control buttons for DVD players/recorders (**)
- ⑲ = Go back to previous menu
- ⑳ **OK** = Enter
- ㉑ **GUIDE** = Index Page / Guide for DTT
- ㉒ = TXT Subtitle in TV mode; Subpage in teletext mode.
- ㉓ = Reveal
- ㉔ **BLUE** (Only use in Teletext mode)
- ㉕ **YELLOW** (audio language)
- ㉖ **P+/-** = Programme Up/ Down
- ㉗ **I/II** = Mono/Stereo - Dual A-B
- ㉘ = PIP, PAP On-Off / PAT
- ㉙ **0 - 9** = Digit buttons

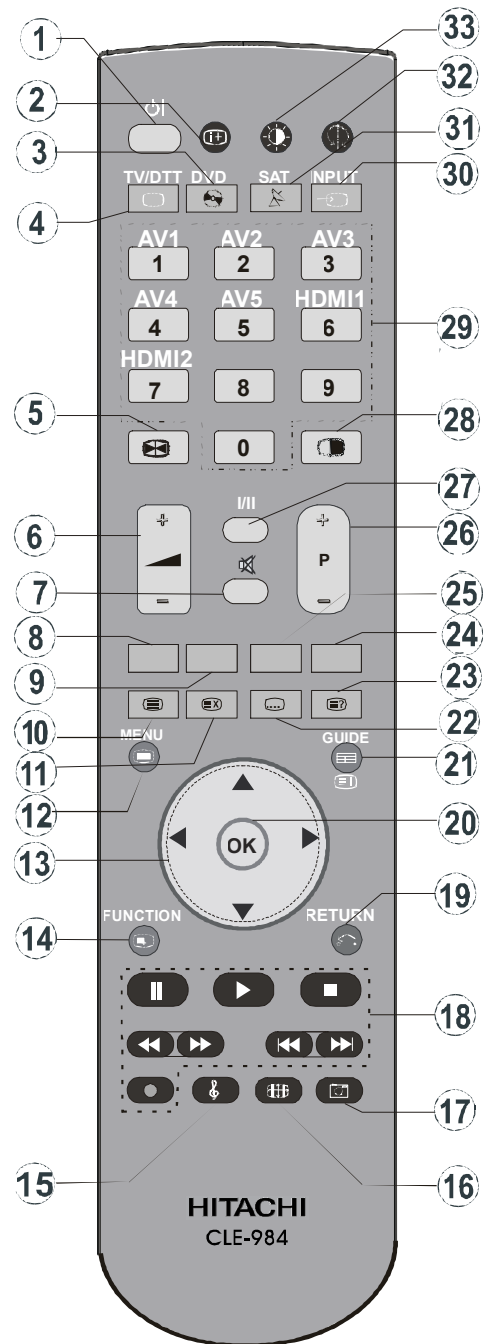

- ⑳ **INPUT** = INPUT
- ㉑ **SAT** = Select SAT
- ㉒ = No function
- ㉓ = Picture mode

For source selection, first press **INPUT** button on the remote controller then source button (AV1, AV2, AV3, AV4, AV5, HDMI1, HDMI2) which you want to switch.

** These buttons can control most Hitachi DVD Players and Recorders.

Installation Of The TFT TV To The Wall

- 1- To install the TFT TV on the wall, first of all, foot assembly should be removed. (Figure 1). Unscrew the 6 screws (M4 x 12) that attach the foot assembly to the TFT panel and remove the foot assembly from the TFT panel.
- 2- Decide the place on the wall where the TFT panel would be placed. Fix the **wall mounting stencil** on the wall.
The stencil is used for placing the wall hangers on the wall, properly.
- 3- Level and mark with a pencil the 4 mounting points on each wall hanger.
Drill pilot holes for the plastic anchors (7x30) and then fix the wall hangers with 8 screws (4 x 30).
- 4- Raise the TFT panel and hang it to the holes on the wall hanger from the 4 hanging screws at the rear of the TFT panel.

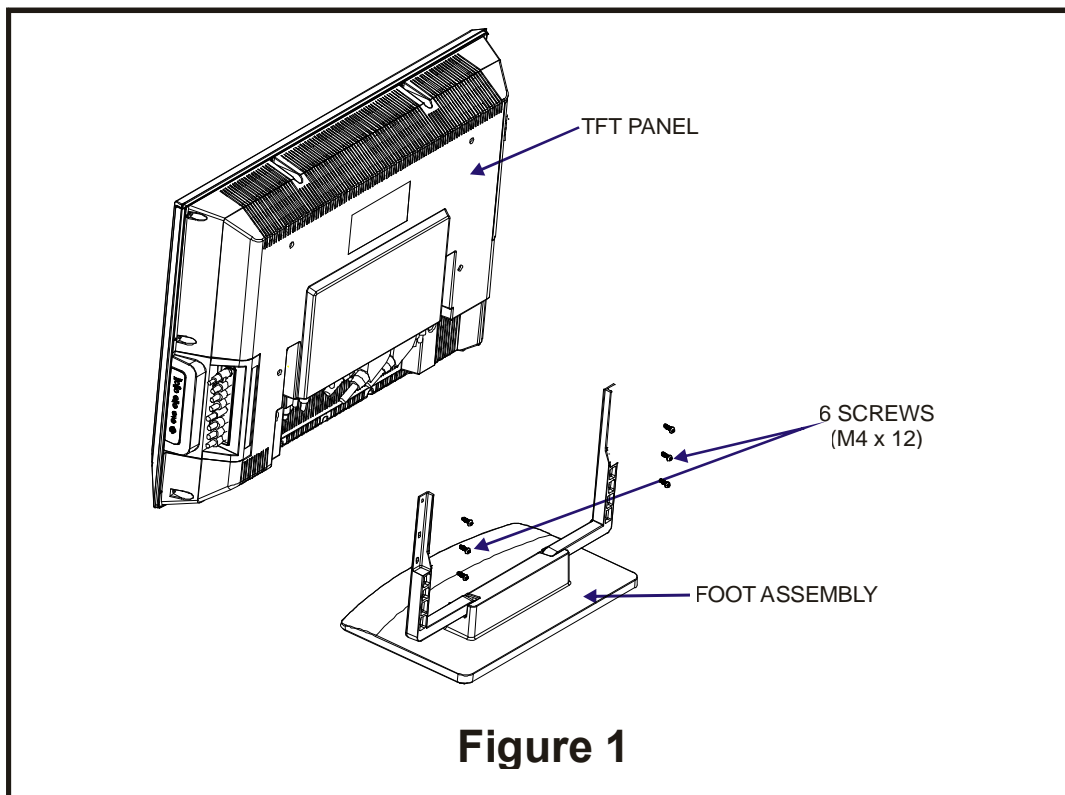

Figure 1

IMPORTANT

1. Please follow the installation instructions carefully as failure to do so may result in injury or damage to the set.
2. If you do not feel confident in carrying out the installation yourself, please ask a specialist installer to carry out the installation for you.
3. The wall anchors provided are for solid (brick, concrete etc) walls only. For all other wall types please obtain the correct fixings for the wall type from your hardware retailer. If you are unsure which anchors to use, please seek professional advice.
4. To avoid potential injury it is advisable to have assistance from another person to carry out this installation.
5. Hitachi assumes absolutely no responsibility for injuries or damages that may occur due to improper installation and handling.

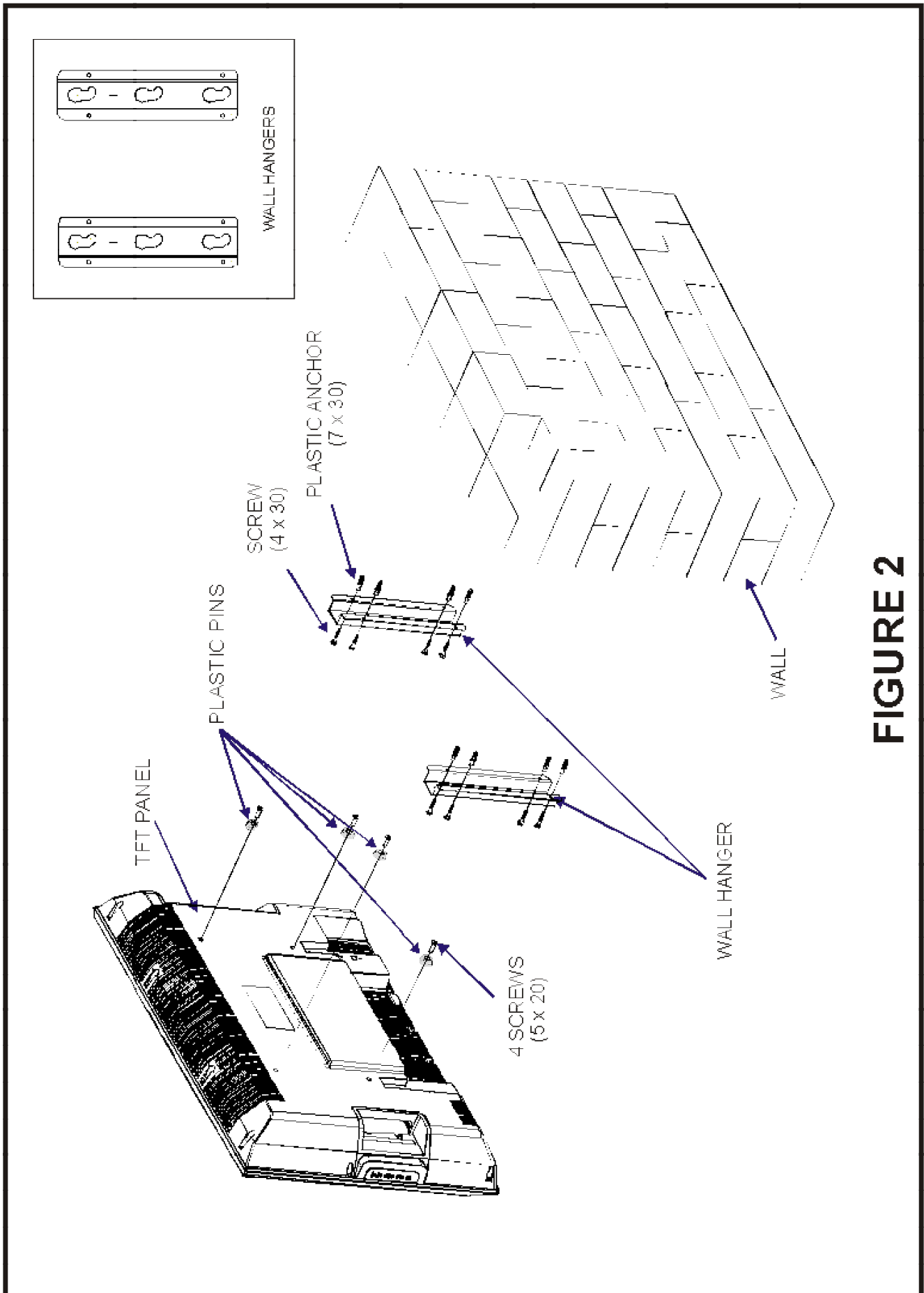

FIGURE 2

“Attention: Only the original wall bracket should be used with this product”

Preparation

For ventilation, leave a space of at least 10 cm free all around the set. To prevent any fault and unsafe situations, please do not place any objects on top of the set.

Use this apparatus in moderate climates.

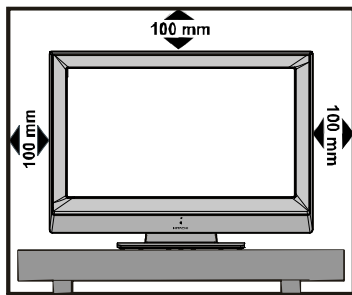

Before Switching On Your TV

Power Connection

IMPORTANT: The TV set is designed to operate on **220-240V AC, 50 Hz.**

- After unpacking, allow the TV set to reach the ambient room temperature before you connect the set to the mains.

Connections To The Aerial Input Socket

- Connect the aerial or cable TV plug to the Aerial input socket located at the rear of the TV and connect the cable plug coming out from the TV out socket located on the devices (VCR, DVB etc.) to this socket as well.

Inserting Batteries In The Remote Control Handset

WARNING : Remote control is battery included. A plastic protector is used to disconnect the batteries in order to prevent the battery life from reducing. Please remove the plastic protector before the first use.

- Remove the battery cover located on the back of the handset by gently pulling backwards from the indicated part.
- Insert two **AA/R6** or equivalent type batteries inside. Place the batteries in the right directions and replace the battery cover.

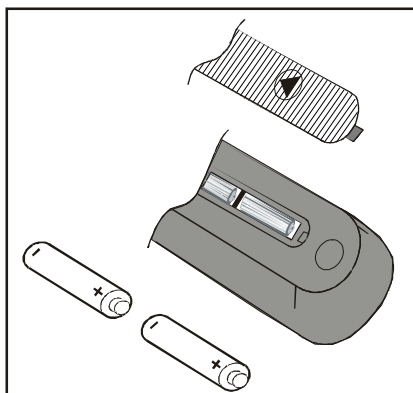

Note: Remove the battery from remote control handset when it is not to be used for a long period. Otherwise it can be damaged due to any leakage of battery.

Handling the Remote Control

- It could cause corrosion or battery leakage and may result in physical injury and/or property damage including fire.
- Never mix used and new batteries in the device.
- Replace all the batteries in a device at the same time.
- Remove the batteries if the remote control is not going to be used for an extended period of time.
- To avoid possible failure, read the following instructions and handle the remote control properly.
- Do not drop or cause impact to the remote control.
- Do not spill water or any liquid on the remote control.
- Do not place the remote control on a wet object.
- Do not place the remote control under the direct sunlight or near sources of excessive heat.

Note: Remove the battery from remote control handset when it is not to be used for a long period. Otherwise it can be damaged due to any leakage of battery.

Operating Range for the Remote Control

- Point the top of the remote control toward the LCD TV's remote sensor LED while pressing a button.

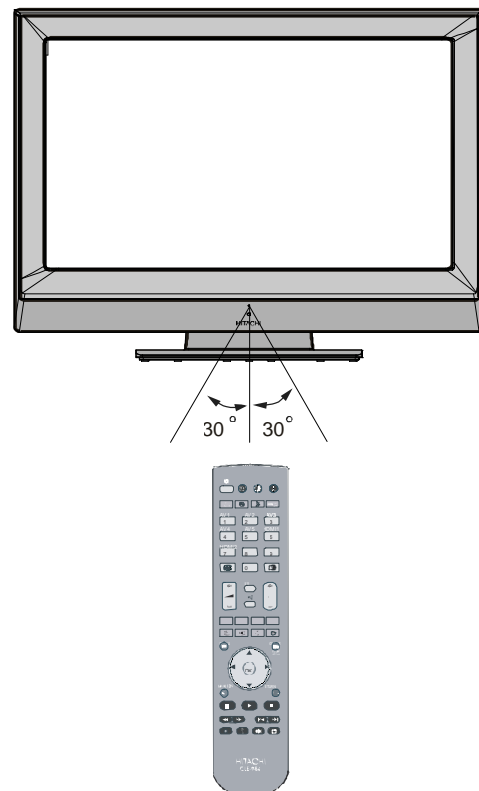

Remote range is approximately 7m/23ft.

Switching The TV ON/OFF

To switch the TV on:

Your TV will switch on in two steps:

- 1- Connect the power cord to the system. Press Power On/Off switch. Then the TV switches itself to stand-by mode (optional).
- 2- To switch on the TV from stand-by mode either:
Press a digit button on the remote control so that a programme number is selected, or Press the "-P/CH" or "P/CH+" button on the TV or press the P+ or P- button on the remote control, so that last mode switched off is selected.

By either method the TV will switch on.

To switch the TV off:

- Press the "⏻" (stand-by) button on the remote control or On/Off switch on the TV, so the TV will switch to stand-by mode.

To power down the TV completely, press On/Off switch

or,

Unplug the power cord from the mains socket.

Navigating the Menu System

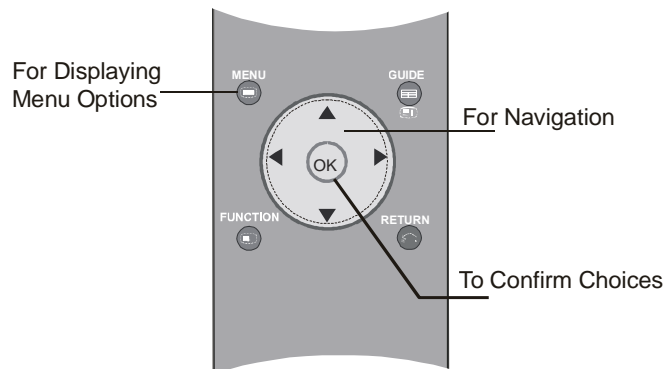

- 1- Press to display the menu.
- 2- Press button to select an icon.
- 3- Use button to highlight. Press for more options in analogue TV mode. Use **OK** in DTV mode for viewing a submenu.
- 4- Press buttons to change the settings. Press **OK** to set as default.
- 5- To exit the menu or return from sub-menu screen, press .

These explanations are available for the navigation of the whole menu system. To select options that are explained in the following parts, refer to "Navigating The Menu System".

Initial Settings

When the TV is turned on for the first time, IDTV is on first. Because this is the first time that IDTV has been used, there are no channels stored in the memory.

When the TV is turned on for the first time, the menu for the language selection appears on the screen. The message "**Welcome please select your language!**" is written in all language options sequentially in the menu on the screen.

By pressing or buttons highlight the language you want to set and press **OK** button. In the menu "Set Language" is written next to "OK" item to indicate that "Press SELECT button to set the highlighted language option."

You can get information about the menu usage by pressing button. And press button again to exit the help menu.

After then, First time Installation Menu will appear on screen. By pressing or buttons, selected country item you want to set and press **OK** button.

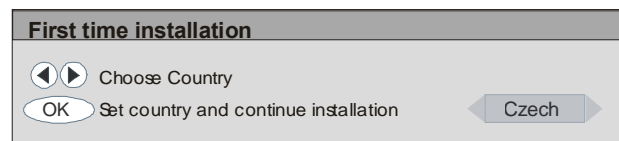

After the First time Installation is set, the following message appears on the screen.



- To start automatic search, select **Yes**, to cancel select **No**.
- To select an option "**Yes or No**", highlight the item by using or buttons and press **OK** button.

The IDTV will automatically tune to the transmission channels according to selected country standards looking for digital terrestrial TV broadcasts and displaying the names of channels found. This process will take about five minutes. To cancel searching, you can press button at any time during the process.

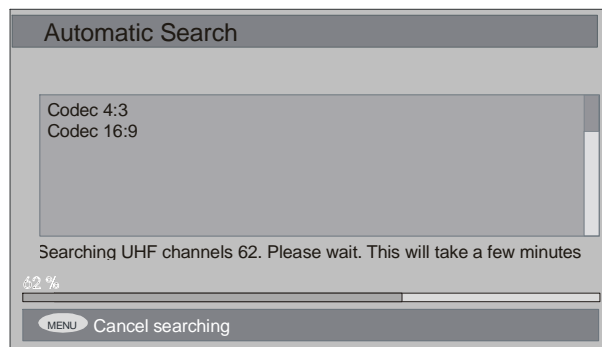

After **Automatic Search** process is completed, the following message asking for analogue channel search appears on the screen. TV switches to the analogue TV mode:



By pressing ◀ or ▶ button, adjust the **Country** item and press ▼ to highlight **Language** item. Use ◀ or ▶ button to set **Language**. Use ▲ or ▼ buttons to select **TXT Language** and set it by using ◀ or ▶ buttons. Press **OK** button to continue:

For more information on this process, see “**Install Menu**” section.

Everyday Operation

Pressing the **TV/DTT** button at any time while watching television programmes will switch the TV set between the digital terrestrial television broadcasting and the analogue broadcasting.

Information Banner

- Whenever you change the channel using the **P +** or **P -** buttons or the number buttons, TV displays the channel picture along with an information banner at the bottom of the screen. This will remain on the screen for approximately three seconds.
- The information banner can also be displayed by pressing the **i+** button at any time while watching the TV. Pressing the **i+** button again removes the banner.

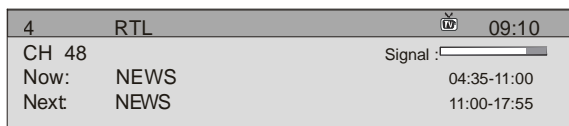

The information banner gives a number of facts on the channel selected and the programme on it:

- The name of the channel is displayed along with its channel list number and an indication of the strength of the signal received on this tuning channel.

- The current and next programme information are given with the start and finish time.
- The current time information is displayed along with channel name.

Hint

Not all channels broadcast the programme data. If the name and times of the programme are not available then “No Information Available” is displayed in the information banner.

If the selected channel is locked, you must enter the correct four digit key to view the channel.

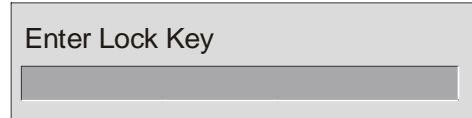

ELECTRONIC PROGRAMME GUIDE(EPG)

Some, but not all, channels send information about the current and next events. Please note that event information is updated automatically. If there is no event information data available for channels, only channel name with “**No Information Available**” banner is displayed.

- Press **GUIDE** button to view the **EPG** menu.
- Press ▲ or ▼ buttons to navigate in Channels or Programmes.
- Press ◀ or ▶ buttons to navigate through the channel and programme list.
- In EPG Menu, you can easily see the extended help information by pressing the **i+** button and by pressing this button again you can close this window.

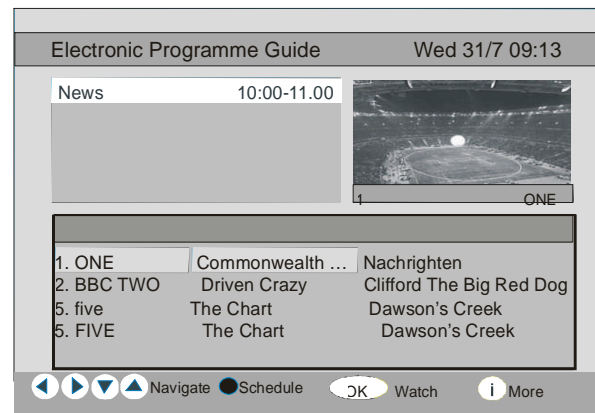

- In the EPG Menu all channels are displayed. The current channel is highlighted when you enter the EPG menu.
- Use ▲ or ▼ buttons to change the channel. Also press **RED** or **GREEN** buttons to make page up/down scroll for the channels. And press **OK** button to watch the highlighted channel.
- If you highlight an event, short event description, extended event description, start and finish time of the event are displayed on the screen.

- If you press **OK** button when a next event is highlighted, a reminder is set for the highlighted programme and a clock icon appears across the highlighted channel line as shown in the following EPG menu figure.

Programme reminders is set to signal that a programme is about to start when you are watching another channel. If you set reminder to a programme, then you will be asked for switching to that channel when the reminder time is reached.

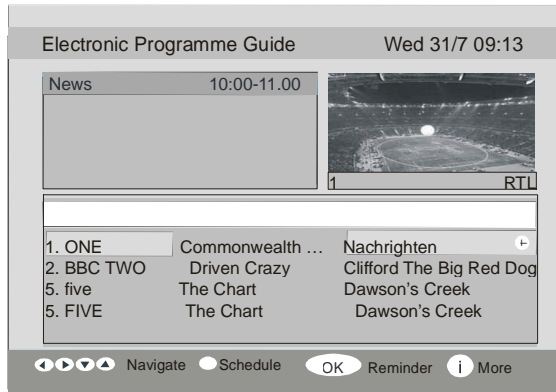

- By pressing the **BLUE** button you can view the extended schedule of the programmes.
- By pressing the **i+** button you can see the detailed help information easily. And by pressing **i+** button again you can exit Help menu.

By pressing the **BLUE** button, the following EPG Menu appears on the screen.

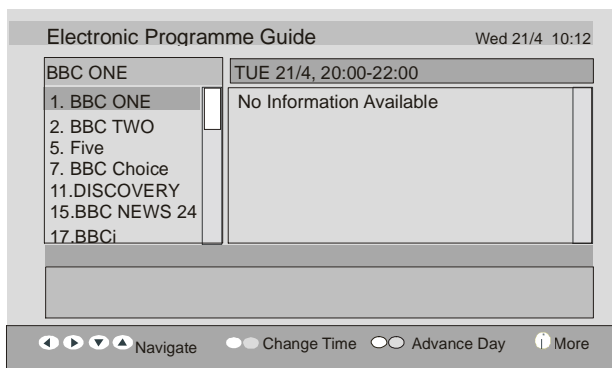

- By pressing **YELLOW / BLUE** button, you can advance the schedule backward / forward of a day.
- By pressing **GREEN / RED** buttons you can change the schedule time.
- If you press **i+** button you can see the detailed help information easily. And by pressing **i+** button again you can exit Help menu.

Displaying The Subtitles

With Digital terrestrial broadcasting (DVB-T), some programmes are broadcast with subtitles. Subtitles can be displayed when watching these programmes.

- Whenever **GREEN** button is pressed, Subtitle selection OSD will be displayed on the screen. You can

set Subtitles as **ON** or **OFF**. For Subtitle Language options, refer to “Language Settings” in the “Configuration Menu” section.

TELETEXT

Use of teletext and its functions are identical to the analogue text system. Please do refer to the “Analogue teletext” explanations.

DTV Menu System

The IDTV Menu can only be shown when watching Digital terrestrial broadcasting. Press the **TV/DTT** button to turn the IDTV on while TV is in the analogue mode.

Press **TV/DTT** button.

The menu below appears on the screen:

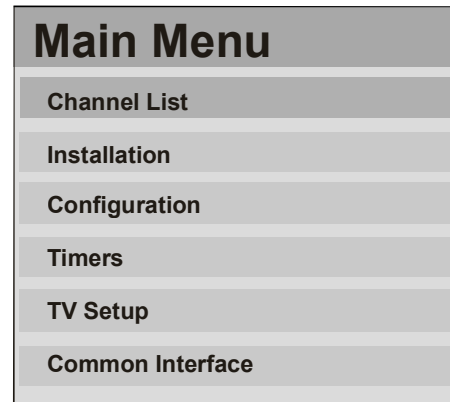

Channel List

Using **▲** or **▼** buttons on the remote control in Main menu, make sure that the first item, Channel List, is highlighted and press the **OK** button to display the **Channel List**.

The following operations can be performed in this menu:

1. Navigating the whole list of channels
2. Moving channels*
3. Deleting channels
4. Renaming channels
5. Adding locks to channels
6. Setting favourites

*Depending on your selection of Country in the first time installation, “MOVE” option of the Channel List may not be visible.

Channel List is the place where the channels are managed.

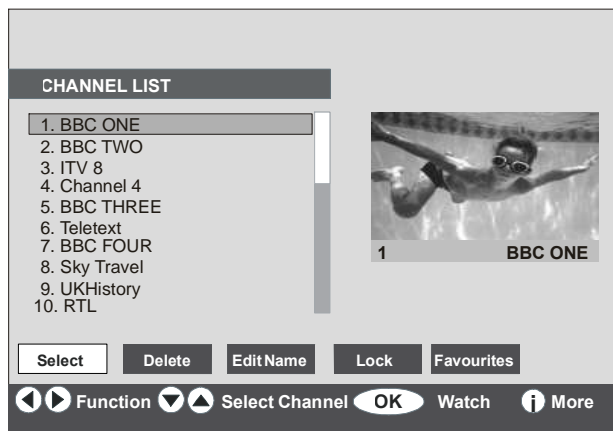

Navigating the whole channel list

- Press ▲ or ▼ keys for selecting the previous or next channel.
- You can press ▲ or ▼ buttons to move page up or page down.
- To watch a specific channel, highlight it using ▲ or ▼ buttons and then press **OK** button, while the “**Select**” item on Channel List menu is highlighted via using ◀ or ▶ buttons.

Moving the channels in the channel list

- Press ▲ or ▼ buttons to select the channel that will be moved.
- Press ◀ or ▶ buttons to select the “**Move**” item on Channel List menu.

“Move” is written next to “OK” item to indicate that press **OK** to move the highlighted channel to the desired position on the channel list.



- Press **OK** button, the selected channel becomes highlighted.
- Use ▲ or ▼ buttons to select the new position of the channel and press **OK** button to place the channel to the selected position and return the menu.

Deleting the channels in the channel list

- Press ▲ or ▼ buttons to select the channel that will be deleted.

- Press ◀ or ▶ buttons to select the “**Delete**” item on Channel List menu.

As seen on Channel List menu, “Delete” is written next to **OK** item at the bottom of the screen to indicate that press **OK** button to delete the highlighted channel in the channel list.

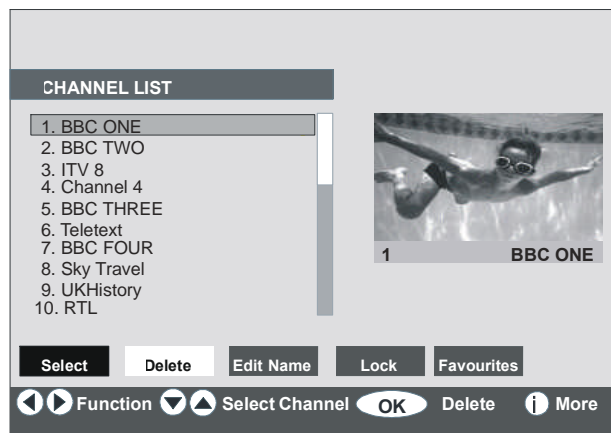

Press **OK** button to delete the highlighted channel in the channel list. Then the message below appears on the screen.

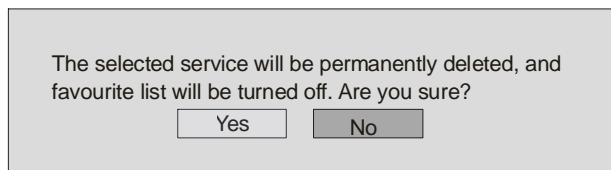

- Press ◀ or ▶ buttons to highlight the desired option.
- If **OK** button is pressed while “Yes” is highlighted, the highlighted channel is deleted.
- Selecting “No” cancels the delete operation.

Renaming channels

To rename a specific channel, the channel must be highlighted via pressing ▲ or ▼ buttons and then highlight the “**Edit Name**” item by pressing ◀ or ▶ buttons. Press **OK** button to activate rename feature.

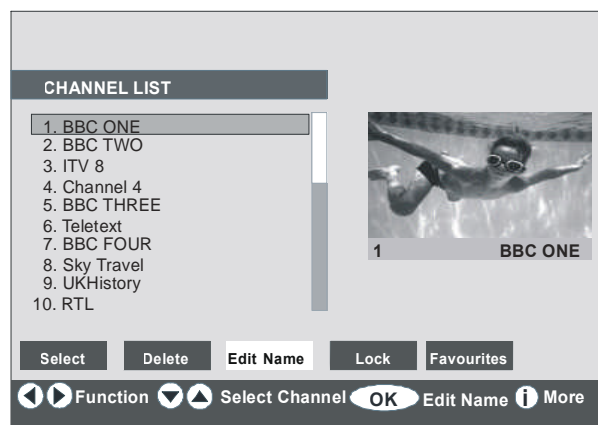

Now pressing ◀ or ▶ buttons moves to the previous/next character. Pressing ▲ or ▼ buttons

toggles the current character, i.e., 'b' character becomes 'a' on ▼ and 'c' on ▲. Pressing the numeric buttons '0...9' replaces the highlighted character with the characters printed above the key one by one as the button is pressed.

Press the  button to cancel the editing or **OK** button to save the new name.

Adding locks to channels

Channel Locking provides a password-protected access to channels selected by parents.

In order to lock a channel you should know the Parental Lock password (default value is set to 0000 in the factory and can only be changed from the **Configuration Menu**).

By pressing ▲ or ▼ buttons, highlight the channel to be locked and select the "Lock" option by pressing ◀ or ▶ buttons. Then press the **OK** button, a password box is displayed.

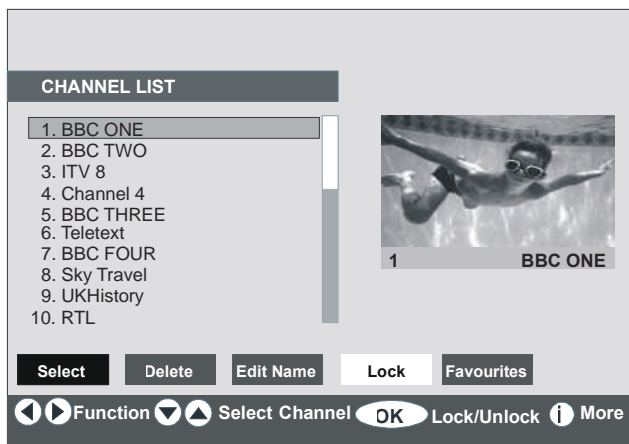

Setting Favourites

You can set various channels as favourites so that only the favourite channels are navigated. To set a favourite you should highlight the "Favourites" item at bottom of the Channel List menu.

To set a favourite you should highlight the "Favourites" item at bottom of the Channel List menu, and then pressing **OK** key, **Edit Favourite Lists** menu appears on the screen.

You can list your favourite channels using List 1, List 2, List 3, List 4 or List 5.

Using 5 lists enables listing channels for different categories (sport, music etc.). And by activating the favourites list number that you want in **Favourite Mode** submenu of Configuration menu, you enable only the channels in the selected list. Configuration menu is entered from the Main Menu.

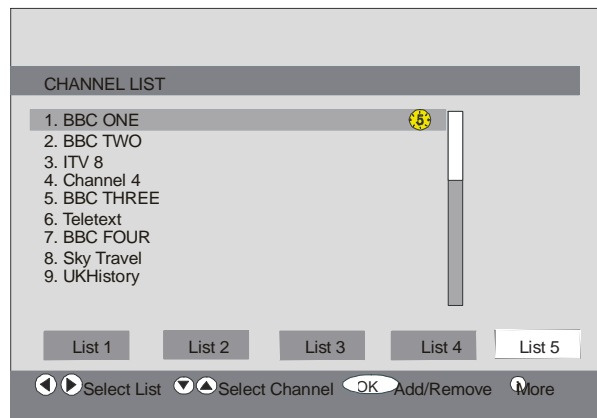

How To Add A Channel To A Favourite List:

- By pressing ▲ / ▼ buttons, highlight the channel that you want to add to the favourite list.
- Select the list number by pressing ◀ / ▶ buttons.
- By pressing , the highlighted channel is added to selected list number.

For each channel, an icon indicates which favourite list a channel is in. (i.e. In figure above,  icon indicates that BBC ONE is added to **List 1**.)

To remove any channel that is added to a favourite list:

- Highlight the channel that you want to remove from the favourite list you have added;
- Highlight the list number that the channel will be removed, and press **OK** button. The icon indicating the added list number disappears on the menu.

Note: A channel can be added to more than one favourite list.

To activate **Favourites**, go to the Configuration menu and select the list number in **Favourite Mode** you want to activate by pressing ◀ or ▶ buttons. To cancel Favourites, set **Favourite Mode** to Off.

Using BLUE button to navigate through the favourite channels:

You can navigate through the favourite channel lists via pressing **BLUE** button. For each pressing of **BLUE** button, you can navigate through the favourite channels that are top of the each channel list, sequentially. While a channel list is selected, you can navigate through the favourite channels in that list by pressing **P +** or **P -** buttons.

On Screen Help Pressing INFO Button

For all menus press  button to display the help information about the menu functions. For **Channel List** menu the following message is displayed on the screen.

Press the SELECT button on your remote control to tune to the highlighted channel.
Press MENU to exit this screen.

Hint:

Entering More item pressing  button gets quick and easy use of the all menus in IDTV displaying information for the highlighted menu item.

Installation

The Installation menu mainly intends to help you for building a **Channel Table** in most efficient way.

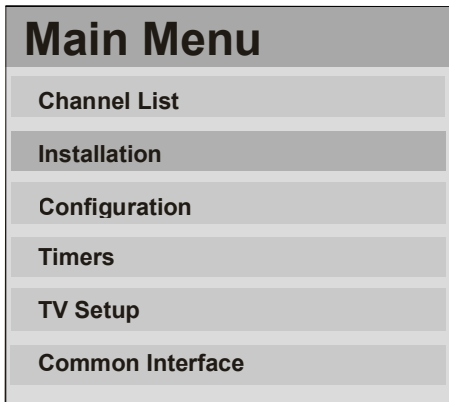

This menu includes the following items:

1. Automatic Search
2. Manual Search
3. First Time Installation

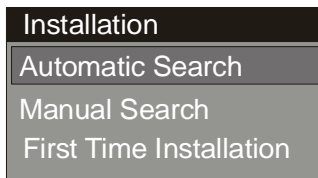

Automatic Search:

Automatic search is started by pressing **OK** button while **Automatic Search** item is highlighted.

The following message appears on the screen.

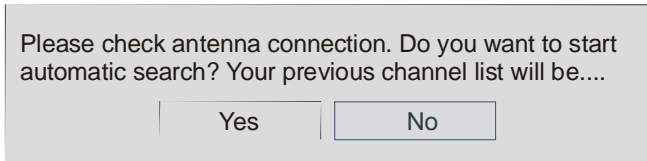

Highlight "Yes" or "No" via using ◀ or ▶ buttons and press **OK** button to select.

If "Yes" is selected, Automatic Search is started.

Selecting "No" cancels Automatic Search.

After search is completed for digital channels, a message asking search for analogue channels appears on the screen.

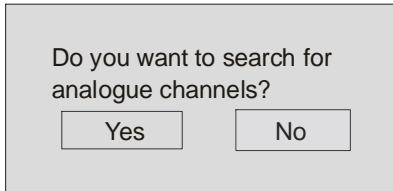

Highlight "**Yes**" and press **OK** button to search for analogue channels. The following menu appears on the screen for analogue channel search.

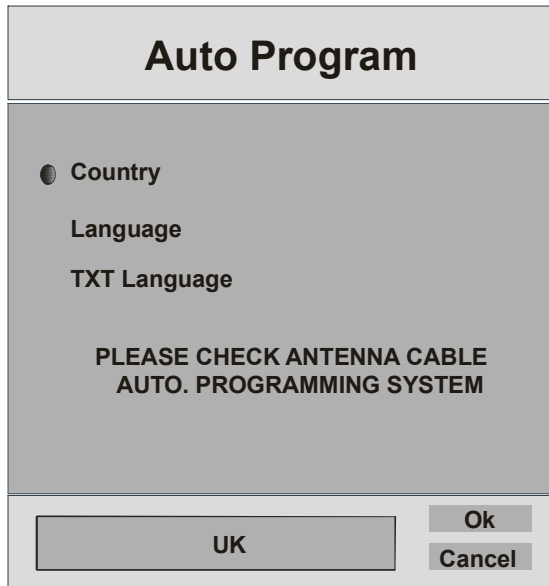

By pressing ◀ or ▶ button, adjust the **Country** item and press ▼ to highlight **Language** item. Use ◀ or ▶ button to set **Language**. Use ▲ or ▼ buttons to select **TXT Language** and set it by using ◀ or ▶ buttons. Press **OK** button to continue:

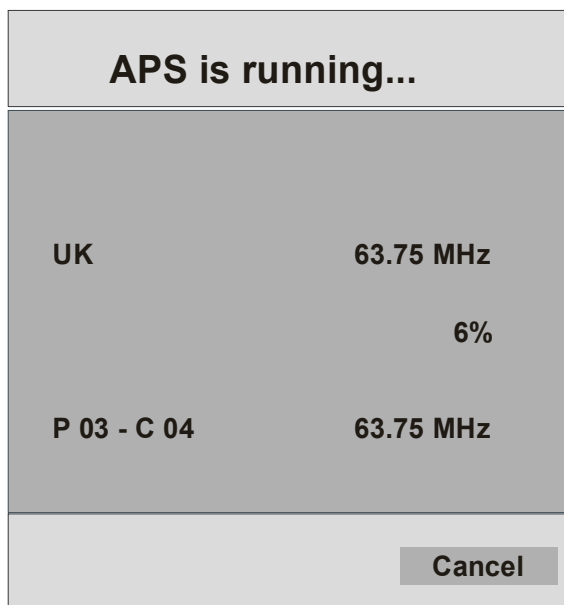

After APS is finalized, the programme table will appear on the screen. In the programme table you will see the programme numbers and names assigned to the programmes.

If you do not accept the locations and / or the

programme names, you can change them in aps sub-menu in the settings menu.

All the services are searched and a channel table is created automatically.

All channels found are stored in a sorted form with respect to their channel numbers. Some services may not appear with the correct channel number. At the time of printing, not all broadcasters are sending their channel number information.

Manual Search:

In **Manual Search**, the number of the multiplex is entered manually and only that multiplex is searched for the channels. For every valid channel number, signal level, signal quality and network name are shown at the bottom of the screen.

In both manual and auto search any existing channel in the database is not re-stored to avoid redundant duplicates of that channel.

First Time Installation

The user can use this item to load default settings, which had been loaded to the receiver at the factory.

To install factory settings, highlight **“First Time Installation”** menu item and press **OK** button, then you will be asked to delete existing channels. Selecting **“Yes”** by pressing **OK** button while the **“Yes”** is highlighted and then the existing channel table will be deleted.

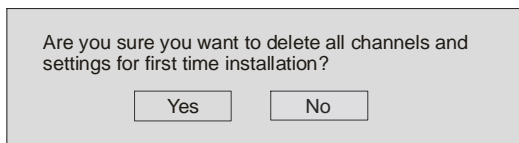

After factory settings is loaded, **“First Time Installation”** menu will be displayed.

The menu which is displayed for language selection appears on the screen at first. By using **▲** or **▼** buttons, select the desired language option, and press **OK** button to activate.

After the language is selected, a message asking for automatic search start appears on the screen.

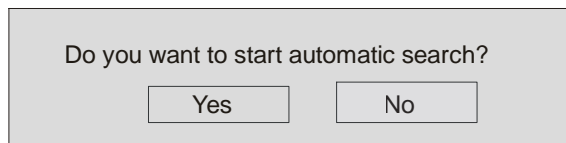

Highlight **“Yes”** item by pressing **◀** or **▶** buttons and press **OK** button to start installation. After search is completed for digital channels, a message asking search for analogue channels appears on the screen.

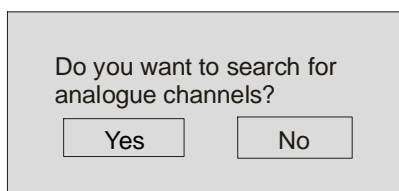

Highlight **“Yes”** item by pressing **◀** or **▶** buttons and press **OK** button to search for analogue channels. The following menu appears on the screen for analogue channel search.

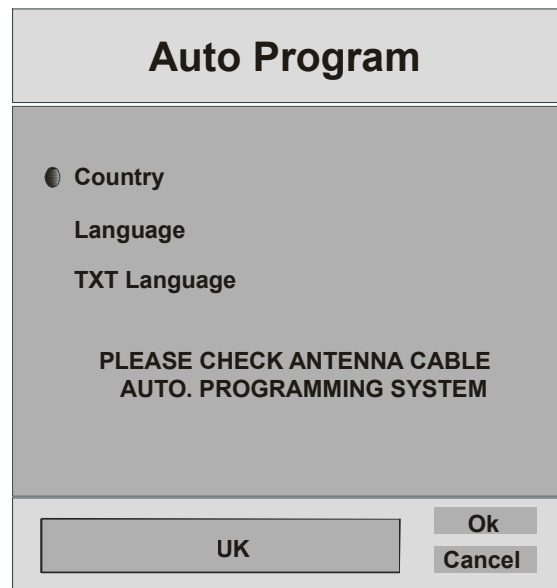

By pressing **◀** or **▶** button, adjust the **Country** item and press **▼** to highlight **Language** item. Use **◀** or **▶** button to set **Language**. Use **▲** or **▼** buttons to select **TXT Language** and set it by using **◀** or **▶** buttons. Press **OK** button to continue.

Configuration

Press **⏪** button to display the Main Menu and the **▼** button twice to highlight Configuration, then press **OK** button to display the Configuration menu. Press **⏩** button to exit the menu.

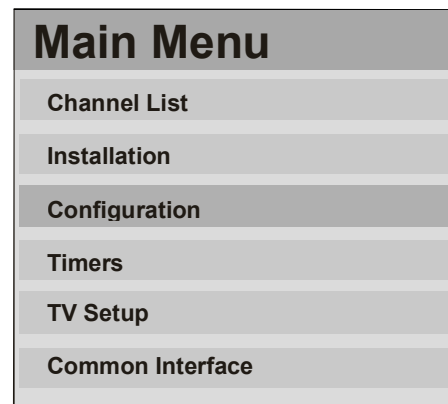

The various configuration functions are displayed in a list, along with a quarter-screen image of the currently selected channel. You can select a function by highlighting the corresponding menu line using the **▲** or **▼** buttons.

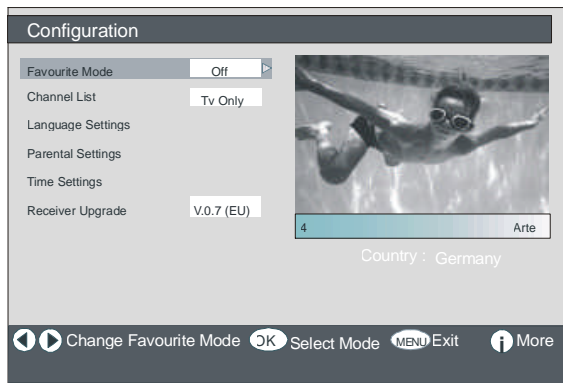

Favourite Mode

This function enables or disables the favourite channel list mode.

Use ◀ or ▶ buttons to set Favourite Mode to “List 1, List 2,..., List 5 or Off”.

Selecting “Off” disables the favourite channel List mode.

If the “**Favourite Mode**” is set on via selecting a channel list number, in normal operating mode pressing **P +** and **P -** buttons will only navigate through the channels that were previously defined as favourites in the selected channel list.

Channel List

In the Configuration Menu, highlight the **Channel List** item by pressing ▲ or ▼ buttons.

Use the ◀ or ▶ buttons to set the **Channel List** to “TV only or Radio only”.

This feature enables navigation only through the selected channel list type.

If “Radio only” is set, you can only navigate through the Radio channels in the channel list via using **P +** or **P -** buttons.

Language Settings

In the configuration Menu, highlight the Language Settings item by pressing ▲ or ▼ buttons. Press **OK** and Language Settings sub menu will be displayed on the screen:

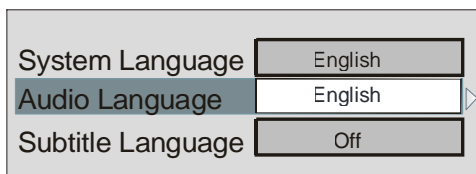

Use ▲ or ▼ buttons to highlight the menu item that will be adjusted.

System Language

System Language determines the on-screen menu language.

Use ◀ or ▶ buttons to set the System Language setting.

Audio Language

Digital terrestrial television channels can broadcast simultaneous soundtracks in more than one language. This function selects which language soundtrack you will hear when switching to a channel broadcasting with the multiple soundtracks.

Use ◀ or ▶ buttons to cycle through the language options.

Subtitle Language

Digital terrestrial television channels can broadcast with subtitles displayed on-screen for the hard-of-hearing. This function selects the desired subtitle language and enables the automatic display of subtitles whenever subtitle information is broadcast.

Use ◀ or ▶ buttons to cycle through “Off” and language options.

Parental Settings

Some channels broadcast material which you do not want younger members of the family to watch. Any channel can be ‘locked’ so that it cannot be selected for viewing without first a four-digit PIN code being entered. In this way any channel not suitable for younger viewers can be protected.

This function enables or disables the menu protection system and allows the PIN code to be changed. Channel And Menu Protection Lock feature.

Use ▲ or ▼ buttons to highlight Parental Settings. Press **OK** button to enter Parental Settings Menu. A box asking for the lock key is displayed.

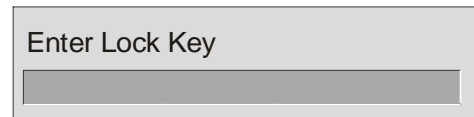

There is only one key which is set to “0000” initially. Enter lock key. If wrong Lock key is entered, the following message is displayed on the screen and it is returned back.

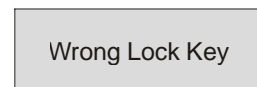

If it is correct, the Parental Settings Menu including following items is displayed:

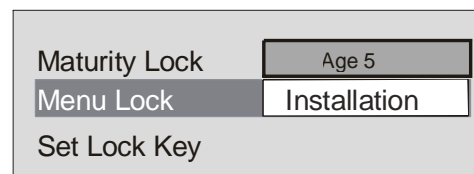

Use ▲ or ▼ buttons to highlight the menu item that will be adjusted.

Maturity Lock:

Use ◀ or ▶ buttons to set Maturity Lock to the “Off,

Age 4, Age 5.....Age17 or Age 18". ("Off, Age 4, Age 5,...., Age 18, Freigegeben ab 6 Jahren, Universal viewing (FRA) or X-rated ESP".)

Menu Lock:

There you can set/reset locking for the Main Menu or the Installation Menu to restrict access. If the menu lock is disabled, there will be free access to the menu system.

Off: All menus are unlocked.

Main Menu: Main menu is accessible only with the correct lock key. So the user cannot add, delete, re-name, move channels, cannot set timers.

Installation: Installation menu is locked, so the user cannot add channels.

Changes will be updated after exiting Configuration Menu.

Set Lock Key:

Also in this menu you can change the lock key and set/change parental lock mode.

Time Settings

In the configuration Menu, highlight the Time Settings item by pressing ▲ or ▼ buttons. Press **OK** and Time Settings sub menu will be displayed on the screen:

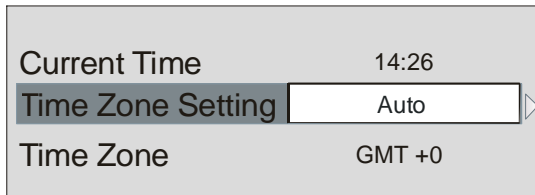

Use ▲ or ▼ buttons to highlight the Time Zone Setting. Time Zone Setting is set using ◀ or ▶ buttons. It can be set to AUTO or MANUAL. When AUTO is selected, Current Time and Time Zone options will not be available to be set.

If MANUAL option is selected as the Time Zone Setting, Time Zone could be altered:

- By pressing ▲ or ▼ buttons select Time Zone. Use ◀ or ▶ buttons to change the Time Zone between GMT-12 or GMT+12. Current Time on the top of the menu list will then change according to the selected Time Zone.

Receiver Upgrade

The IDTV can be upgraded via the configuration menu, entered from the main menu.

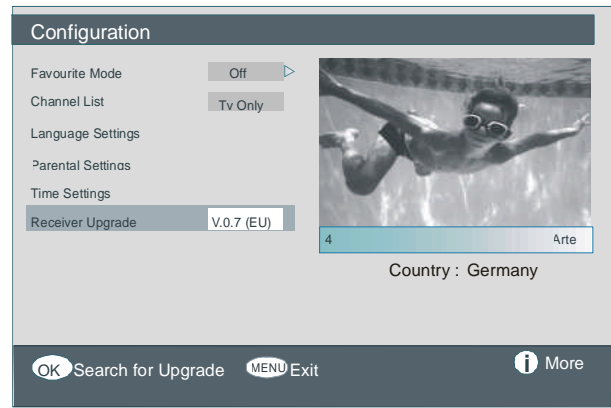

In the configuration menu, highlight the “**Receiver Upgrade**” item by pressing ▲ or ▼ buttons and press “**OK**” button to start upgrade process. The following menu appears on the screen.

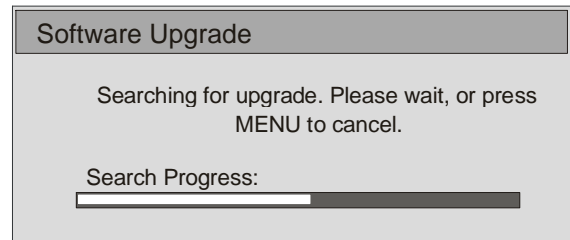

After the search progress is completed, the message “**Completed searching for upgrade. No new software was found**” appears on the screen if no new software is found.

Timers

Display the Main Menu by pressing the  button. Highlight the **Timers** line by pressing ▲ or ▼ buttons and press **OK** button to display the Timer menu.

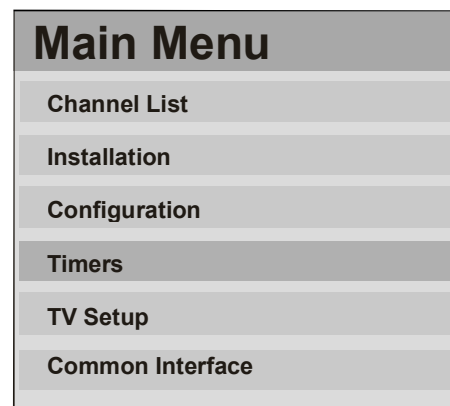

Up to five separate timer events can be set and each is displayed in the Programme Timers screen, showing the event number, the channel to be selected, the start time, end time, date and the mode - whether that event is active (and will be acted on) or not.

Programme Timers					
No	Channel Name	Start	End	Date	Mode
1.	ITV 1	20:00	21:00	12/05/2005	Active
2.	BBC ONE	00:00	00:00	01/01/2005	Inactive
3.	BBC ONE	00:00	00:00	01/01/2005	Inactive
4.	BBC ONE	00:00	00:00	01/01/2005	Inactive
5.	BBC ONE	00:00	00:00	01/01/2005	Inactive
6.	BBC ONE	00:00	00:00	01/01/2005	Inactive

10:42
04/07/2005

◀ Move/Change Exit OK Edit Timer ▶ More

- To set an event, highlight its mode button using ▲ or ▼ buttons and press OK button to display the timer entry window.

Type:	TV
Name:	3. ITV
Start:	00:00
End:	00:00
Date:	03/06/2005
Mode:	Once

- Here the six settings of channel type, channel name, start time, end time, date and frequency mode can be set. You can move freely between each setting using ▲ or ▼ buttons.
- The channel type is set using ◀ or ▶ buttons. It enables displaying only the selected type channels.
- The channel name is set using ◀ or ▶ buttons to display the channel which broadcasts the programme.
- The start time, end time and date are each set with the number buttons on the remote control in 24-hour format.
- The frequency mode determines how often the receiver operates this event and is set with the ◀ or ▶ buttons to be either **Once**, **Daily**, or **Weekly**.

Hint

If an invalid number for the start or end times or the date is entered, "Entered time is not valid" message appears on the menu.

TV Setup

To be able to go through TV functions, you can use this item.

The digital TV Setup menu screen is accessed from the Main Menu. Press the  button to display the Main Menu and use ▲ or ▼ buttons to highlight "TV

Setup". Press OK button to display TV Setup menu screen.

Main Menu
Channel List
Installation
Configuration
Timers
TV Setup
Common Interface

Detailed information for all menu items is in Analogue TV Menu System section.

Common Interface

- Press  button to display the Main Menu and use the ▲ or ▼ buttons to highlight the "Common Interface" line and press OK button.

Main Menu
Channel List
Installation
Configuration
Timers
TV Setup
Common Interface

It is required to subscribe to a pay channel company to view the pay channels of the Digital Terrestrial broadcasting. Obtain the Conditional Access Module (CAM) and the Viewing card by subscribing to a pay channel company, then insert those to the Television using the following procedure.

1. Switch off the TV and unplug from the mains.
 2. Insert the CAM, then Viewing Card to the slot that is located in the terminal cover at the left-hand side of the TV (from front view).
- The CAM should be correctly inserted, it is impossible to insert fully if reversed. The CAM or the TV terminal may be damaged if the CAM is forcefully inserted.
3. Connect the TV to the mains supply, switch on and then wait for few moments until the card is activated.
- Some CAMs may require the following set up. Please set the CAM by entering the IDTV menu, Common Interface then pressing OK button. (CAM set up menu is not displayed when it is not required.)

Analogue TV Menu System

Picture Menu

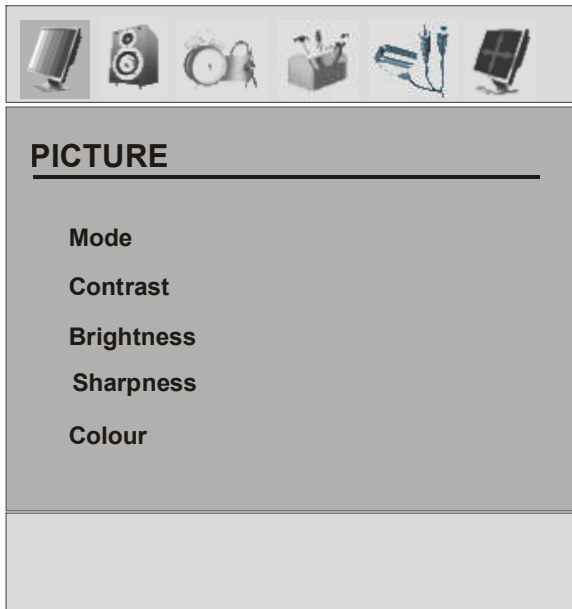

In the picture menu; if PC, YPbPr or HDMI modes is selected, resolution information is displayed at the bottom of the menu OSD.

Mode

By pressing ▲ / ▼ button, select **Mode**. Press ◀ / ▶ button to choose from one of these options: **Cinema**, **Dynamic** and **Natural**.

Contrast/Brightness/Sharpness/Colour/Hue

By pressing ▲ / ▼ button, select the desired Option. Press ◀ / ▶ button to set the level.

Hint: Hue is displayed in picture menu when the TV receives an NTSC signal.

Colour Temp

- By pressing ▲ / ▼ button select **Colour Temp**.
- Press ◀ / ▶ to choose from one of these options: **Cool**, **Normal** and **Warm**.

Noise Reduction

By pressing ▲ / ▼ button select **Noise Reduction**. Press ◀ / ▶ to choose from one of these options: **Low**, **Medium**, **High** or **Off**.

Film Mode

Films are recorded at a different number of frames per second to normal television programmes.

By pressing ▲ / ▼ button, select Film Mode.

Press ◀ / ▶ button to set this feature On or Off. Turn this feature on when you are watching films to see the fast motion scenes clearly.

3D Comb

3D Comb is used to improve colour transitions and colour quality of pictures.

By pressing ▲ / ▼ button, select **3D Comb**. Press ◀ / ▶ button to set this feature On or Off.

Note: 3D Comb feature is not functional in NATURAL picture mode.

Picture Zoom

By pressing ▲ / ▼ button select **Picture Zoom**. Use ◀ / ▶ buttons, to change picture zoom to **Auto**, **16:9**, **4:3**, **Panaromic**, **14:9 Zoom**, **Cinema**, **Subtitle** or **Zoom**.

Reset

By pressing ▲ / ▼ button, select **Reset**. Press ▶ or **OK** button to reset the picture modes to factory default settings.

Sound Menu

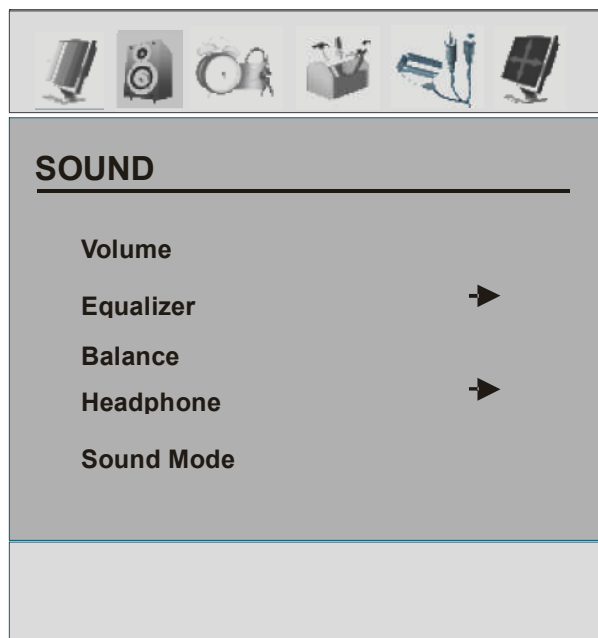

Volume

By pressing ▲ / ▼ select **Volume**. Press ◀ / ▶ button to change the level of the Volume.

Equalizer

By pressing ▲ / ▼ select **Equalizer**. Press ◀ / ▶ button to change the Equalizer setting. In equalizer menu, the mode can be changed to **Pop**, **Rock**, **Jazz**, **Flat**, **Classic** or **User**. Select the desired frequency by ▲ / ▼ button and increase or decrease the frequency gain by pressing ◀ / ▶ button.

Note: Equalizer menu settings can be altered only when the Equalizer Mode is in User.

Balance

By pressing ▲ / ▼ select **Balance**. Press ◀ / ▶ button to change the level of the balance. Balance level can be adjusted between -32 and +32.

Headphone

By pressing ▲ / ▼ button, select Headphone. Press ▶ button to enter headphone menu.

volume

By pressing ▲ / ▼ button, select Volume. Press ▶ button to increase hp volume level. Press ◀ button to decrease hp volume level. Headphone volume level can be adjusted between 0 and 63.

sound mode

By pressing ▲ / ▼ button, select Sound Mode. Press ◀ / ▶ button to change sound mode.

Sound mode is used to identify sound mode of the headphone and can be set to mono, stereo, dual I or dual II according to the transmission.

balance

By pressing ▲ / ▼ button, select Balance. Press ▶ button to increase balance to the right. Press ◀ button to decrease balance to the left. Balance level can be adjusted between -32 and +32.

Press the **MENU** button to return to the previous menu.

Sound Mode

By pressing ▲ / ▼ select **Sound Mode**. Press ◀ / ▶ button, you can select Mono, Stereo, Dual I or Dual II mode, only if the selected channel supports that mode.

AVL

By pressing ▲ / ▼ select **AVL**. Press ◀ / ▶ button to set the AVL as on or off.

Effect

By pressing ▲ / ▼ select **Effect**. Press ◀ / ▶ button to set Effect as on or off.

Dynamic Bass

Dynamic Bass is used to increase bass effect of the TV set.

By pressing ▲ / ▼ button, select Dynamic Bass. By pressing ◀ / ▶ button set Dynamic bass to Low, High or Off. It is not recommended to select High if listening at high volume levels. There is a subwoofer output that can accept an active subwoofer if you wish to create very high levels of Bass.

Subwoofer is active only if Dynamic Bass is set to Off.

Subwoofer

It is possible to connect an external, active subwoofer to the set to give a much deeper bass effect.

By pressing ▲ / ▼ button, select Subwoofer. Subwoofer can be set to On or Off.

Dynamic Bass is not available if Subwoofer is set to On.

Set Subwoofer to On when you connect an external subwoofer to the set.

3DS

By pressing ▲ / ▼ button, select **3DS**. 3DS can be set to On or Off.

Set 3DS to On when you connect an external subwoofer to the set.

If you select "3DS" On, AVL, Effect and Equalizer items will be invisible.

Feature Menu

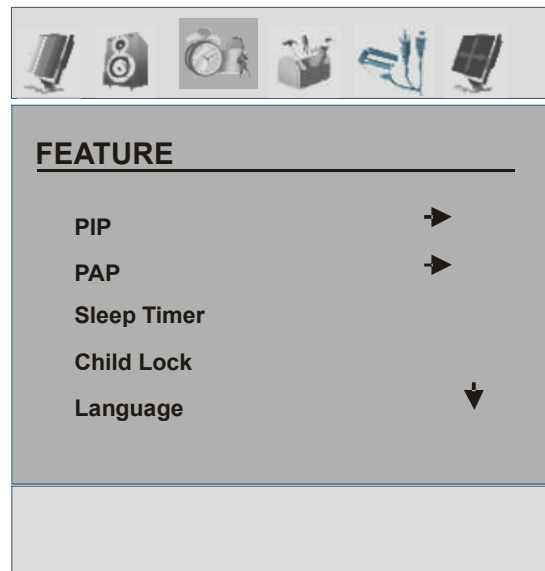

PIP

In the **Feature** menu, highlight **PIP** item by pressing ▲ / ▼ buttons. Press ▶ button to enter **PIP** submenu:

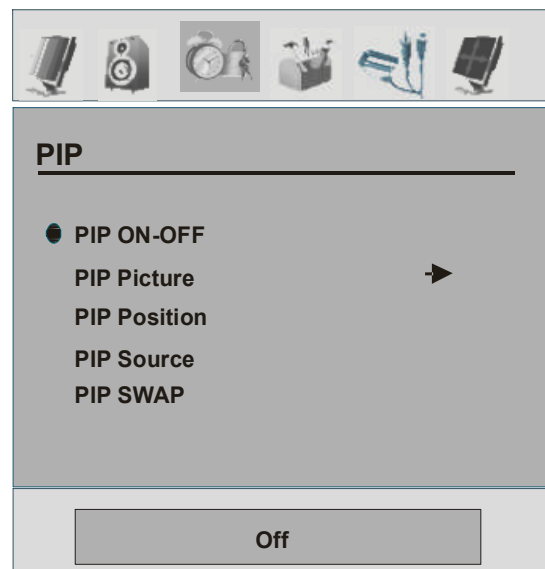

PIP ON-OFF

You can activate or deactivate PIP mode by pressing ◀ / ▶ button.

PIP Picture

Press ▶ button to enter **PIP Picture** submenu. Adjustments of Contrast, Brightness, Sharpness, Colour, Reset and Store items in this part are identical with **Picture menu** in the analogue TV menu System. Refer to Picture menu explanations in the previous parts.

PIP Position

Select **PIP Position** item by using ▲ / ▼ button. Use ◀ / ▶ button to adjust **PIP position**. **PIP Position** info will be displayed at the bottom of the menu OSD. You can directly change PIP position by pressing ▲ / ▼ buttons.

Positions available are: Bottom Right, Bottom Centre, Bottom Left, Top Left, Top Center and Top Right.

PIP Source

Select PIP Source item by using ▲ / ▼ button. Use ◀ / ▶ button to set **PIP source**.

Note: When main picture source is DTT, TV, AV-1, AV-2 or AV-3, PIP Window can only be set to HDMI-1, HDMI-2, AV-5, PC source or vice versa.

PIP SWAP

Select **PIP SWAP** item by using ▲ / ▼ button. Use ◀ / ▶ button to set. This function enables to swap between the main and the PIP picture.

PAP

In the **Feature** menu, highlight **PAP** item by pressing ▲ / ▼ buttons. Press ▶ button to enter **PAP** submenu:

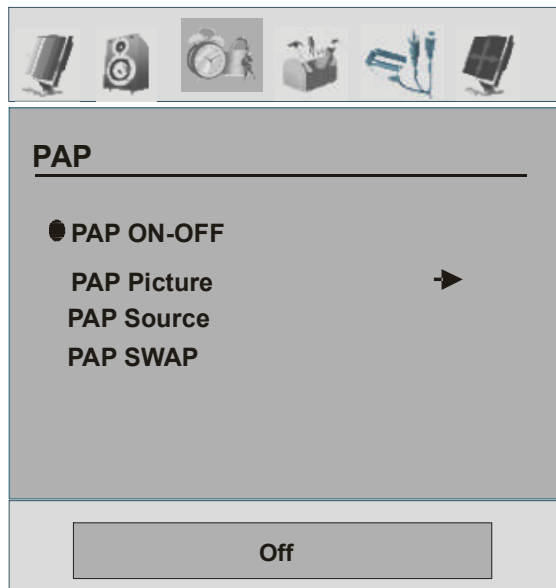

PAP ON-OFF

You can activate or deactivate **PAP** mode by pressing ◀ / ▶ button.

PAP Picture

Press ▶ button to enter **PAP Picture** submenu. Adjustments of Contrast, Brightness, Sharpness, Colour, Reset and Store items in this part are identical with **Picture menu** in the Menu System. Refer to **Picture menu** explanations in the previous parts.

PAP Source

Select **PAP Source** item by using ▲ / ▼ button. Use ◀ / ▶ button to set **PAP source**.

Note: When main picture source is TV, AV-1, AV-2 or AV-3, PIP window can only be set to HDMI-1, HDMI-2, YPbPr (AV-5), PC source or vice versa.

PAP SWAP

Select **PAP SWAP** item by using ▲ / ▼ button. Use ◀ / ▶ button. This function enables to swap between the main and the PAP picture.

Note: See Appendix B for all PIP/PAT modes.

Sleep Timer

By pressing ▲ / ▼ select **Sleep Timer**. Press ◀ / ▶ button to set the Sleep Timer.

The timer can be programmed between Off and 120 minutes in steps of 10 minutes.

Child Lock

By pressing ▲ / ▼ select **Child Lock**.

Press ◀ / ▶ button to set the **Child Lock** on or off. When on is selected, the TV can only be controlled by the remote control handset. In this case the control panel buttons will not work (except for the **STANDBY** button). Hence, if one of these buttons is pressed, "Child Lock On" will be displayed on the screen when the menu screen is not visible.

Language

By pressing ▲ / ▼ button, select **Language**. Use ◀ / ▶ button to select the language. Available language options are; English, French, German, Italian, Spanish, Portuguese, Dutch, Greek, Swedish, Norwegian, Danish, Finnish, Turkish, Croatian, Slovenian, Polish, Czech, Hungarian, Russian, Bulgarian, Greek, Slovak.

AV-2 Out

By pressing ▲ / ▼ select **AV-2 Out**. Use ◀ / ▶ button, to set AV-2 Out to **TV/DTT, AV-1, AV-3, FAV, YPbPr Audio or PC Audio**.

Note: When TV Source is set to HDMI, HDMI Audio setting will be available among AV-2 Out options.

PC Audio In

By pressing ▲ / ▼ select **Pc Audio In**. By pressing ◀ / ▶ button, you can change the PC Audio In to **TV/ DTT, AV-1, AV-2, AV-3, FAV, YPbPr Audio, PC Audio**.

Blue Background

You can set the TV to automatically change to a blue screen if the signal is weak or absent, or when there is no input from an external device.

The Blue Background feature can be turned on or off by pressing ◀ / ▶ button.

Menu Background

By pressing ▲ / ▼ button, select Menu Background. Transparency level is adjusted by pressing ◀ / ▶ button.

Menu Timeout

By pressing ▲ / ▼ button, select Menu Timeout. Press ◀ / ▶ button to change menu timeout to 15 sec, 30 sec or 60 sec.

Teletext Language

By pressing ▲ / ▼ button, select Teletext Language. Press ◀ / ▶ button to change Teletext Language to West, East, Turk/Gre, Cyrillic, or Arabic.

Default Zoom

Default zoom is a feature that provides the zoom mode of the TV set to be switched to the selected default zoom mode (Panoramic, 4:3, 14:9 zoom) in case no WSS or 4:3 signal by end-user.

By pressing ▲ / ▼ button, select Default Zoom. You can set Default Zoom to Panoramic, 4:3 or 14:9 Zoom by pressing ◀ / ▶ button.

Install Menu

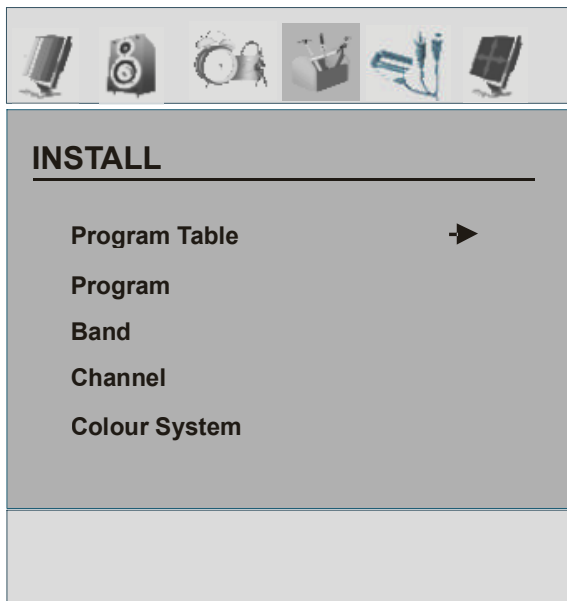

Program Table

By pressing ▲ / ▼ button, select **Program Table**. Press ▶ to display **Program Table**.

Program Table			
P01	BBC 1	P11	S 18
P02	C 04	P12	S 29
P03	C 05	P13	S 31
P04	BBC 1	P14	S 33
P05	CH 4	P15	S 34
P06	BBC 2	P16	S 35
P07	C 04	P17	S 36
P08	C 07	P18	S 37
P09	C 12	P19	S 40
P10	C 15	P20	C 21

Name	Insert
Delete	APS

By moving the cursor in four directions you can reach 20 programmes in the same page. You can scroll the pages up or down by pressing the navigation buttons to see all the programmes in TV mode (except the AV mode). By cursor action, programme selection is done automatically.

Name

To change the name of a decided programme, select the programme and press the **RED** button.

The first letter of the selected name will be highlighted. Press ▲ / ▼ button to change that letter and ◀ / ▶ button to select the other letters. By pressing the **RED** button, you can store the name.

Insert

Select the programme which you want to insert by navigation buttons. Press the **GREEN** button. By navigation buttons move the selected programme to the decided programme space and press the **GREEN** button again.

Delete

To delete a programme, press the **YELLOW** button. Pressing the **YELLOW** button again erases the selected programme from the programme list, and the programmes below shift one up.

APS (Auto Programming System)

When you press the **BLUE** button for APS, Auto Programming System Menu will appear on the screen.

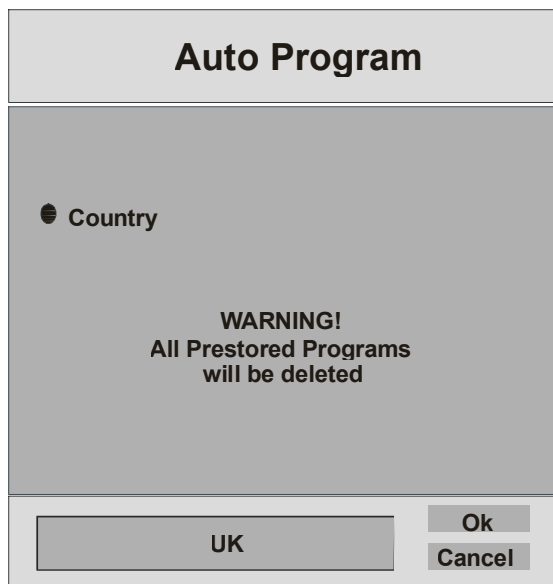

A.P.S. (Auto Programming System) Country

Press ◀ / ▶ button to select your country. If you want to exit from A.P.S. function, press the **BLUE** button.

When you press **OK** or **RED** button for starting APS, all stored programs will be erased and the following screen will be displayed:

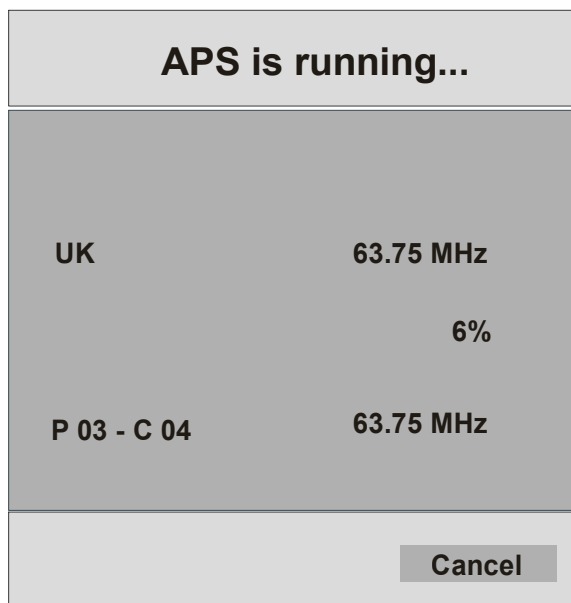

Whenever you press the **BLUE** button, A.P.S. function stops and Program Table appears on the screen. If you wait until the end of A.P.S., Program Table is displayed with the programmes found and located.

Program

By pressing ▲ / ▼ button, select Program. Press ◀ / ▶ button to select the program number. You can also enter a number via digit buttons on the remote control. There are 100 program storage between 0 and 99.

Band

Band can be selected either **C** or **S** by press ◀ / ▶ button.

Channel

Channel can be changed by ◀ / ▶ button or Digit Buttons.

Colour System

By pressing ▲ / ▼ button, select **Colour System**. Press ◀ / ▶ button to change the colour system to **PAL, SECAM, PAL60** or **AUTO**.

If Sound System is set to I, SECAM is not available for the Colour System.

Note: In AV mode, you can choose NTSC 3.58 and NTSC 4.43 as well.

Sound System

By pressing ▲ / ▼ button, select **Sound System**. Press ◀ / ▶ button to change the sound system to BG, I, L, L', DK.

Fine Tune

By pressing ▲ / ▼ button, select Fine Tune. Press ◀ / ▶ button to adjust the tuning.

Search

By pressing ▲ / ▼ button, select **Search**. Press ◀ / ▶ button to start program searching. You can also enter the desired frequency via digit buttons when search item is highlighted.

Store

By pressing ▲ / ▼ button, select **Store**. Press ▶ or **OK** button to store the adjustments. "Stored..." will be displayed on the screen.

Install menu in AV modes

The following screen appears in the install menu:

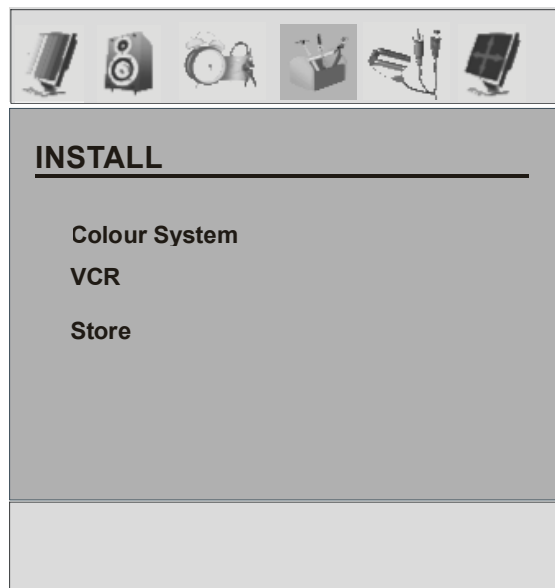

Colour System

By pressing ▲ / ▼ select **Colour System**. By pressing ◀ / ▶ button, you can change the colour system to **PAL, SECAM, PAL 60, NTSC 4,43, NTSC 3,58 or AUTO**.

VCR

By pressing ▲ / ▼ select **VCR**. By pressing ◀ / ▶ button, you can set the VCR to ON or OFF.

Store

By pressing ▲ / ▼ button, select Store. Press ▶ or OK button to store the adjustments. "**Stored...**" will be displayed on the screen.

Source menu

By pressing ◀ / ▶ button, select the fifth icon. Source menu appears on the screen.

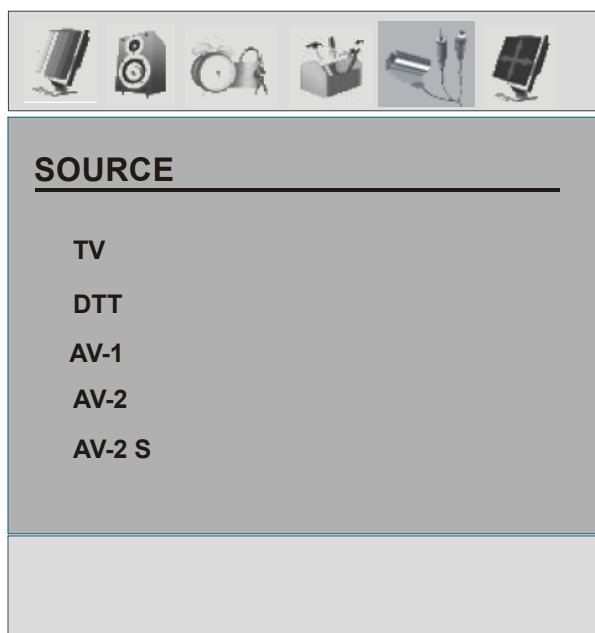

In source menu, highlight a source by pressing ▲ / ▼ button and switch to that mode by pressing ▶ or OK button. Source options are; **TV, DTT, AV-1, AV-2, AV-2 S, AV-3 (*), FAV, S-Video, YPbPr, HDMI-1, HDMI-2 and PC**.

* **Note:** AV-3 is only functional for the models with 3 SCART sockets.

PC Mode

Installation

- Power off both Computer and Display before making any connections.
- Set your PC's resolution correctly before connecting to the TV. See the table on Appendix A on **page 36**.
- Use 15-pin display cable to connect a PC to the LCD TV.

Menu System in PC mode

Sound Menu/Feature Menu

The items in these menus are described at **Sound & Feature Menu** explained in "Menu System".

PC Picture Menu

By pressing ▲ / ▼ button, select the second icon. PC Picture menu appears on the screen.

Brightness, Contrast and Colour Temperature adjustments in this menu are identical to adjustments defined in TV picture menu in "MENU SYSTEM".

PC POSITION Menu

By pressing ▲ / ▼ button, select the sixth icon. PC POSITION menu appears on the screen.

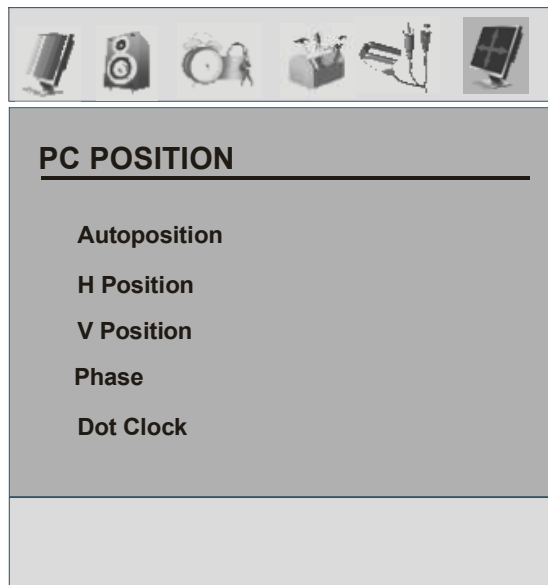

Autoposition

If you shift the picture horizontally or vertically to an unwanted position, use this item to put the picture into correct place automatically.

- Select Autoposition item by using ▲ / ▼ buttons. Press or OK button.

Warning: Auto position adjustment recommended to be done with the full screen image for the proper adjustment.

H (Horizontal) Position

This item shifts the image horizontally to right hand side or left hand side of the screen.

- Select H Position item by using ▲ / ▼ button.
- Use ◀ / ▶ button to adjust the value.

V (Vertical) Position

This item shifts the image vertically towards the top or bottom of the screen.

- Select V Position item by using ▲ / ▼ button.
- Use ◀ / ▶ button to adjust the value.

Phase

Depending on the resolution and scan frequency that you input to the TV Set, you may see a hazy or noisy picture on the screen. In such a case you can use this item to get a clear picture by trial and error method.

- Use ◀ / ▶ button to adjust the value.

Dot Clock

Dot Clock adjustments correct interference that appear as vertical banding in dot intensive presentations like spreadsheets or paragraphs or text in smaller fonts.

- Use ◀ / ▶ button to adjust the value.

Sound in PC mode

- Connect the PC's Audio output to the TV's **PC Audio In** socket with an audio cable.

Other Features

TV Status

Programme Number, **Programme Name**, **Sound Indicator** and **Zoom Mode** are displayed on the screen when a new programme is entered.

Mute Indicator

It is placed in the upper side of the screen when enabled.

Mute

To cancel mute, there are two alternatives; the first one is pressing the  button and the second one is increasing the volume level.

PIP and PAP Modes

PIP picture is displayed on the screen by pressing  button. At PIP Mode, a small picture (PIP picture) is displayed in the main picture.

When PIP Mode is entered, the default active window is PIP window and the active window is indicated by a red frame around it. The active window can be changed by pressing ◀ / ▶ buttons.

PIP position can be changed by pressing ▲ / ▼ buttons.

When  button is pressed again, the TV switches to PAP mode. In PAP Mode, two pictures with equal sizes are displayed on the screen. Aspect Ratios of the windows are fixed.

When you switch to PAP Mode, main window in PAP Mode is displayed on the right side of the screen. The active window can be changed by pressing ◀ / ▶ button.

Press the  button again to exit the PAP mode.

Note: When main picture source is TV, AV-1, AV-2, AV-3 or AV-4; PAP or PIP window can only be set to HDMI-1, HDMI-2, YPBPR, PC source or vice versa.

AV Modes

You can switch your TV to AV modes by using related buttons on the remote control.

First, press  button till **INPUT** OSD is displayed on the screen. You can then use; AV1, AV2, AV3, AV4, AV5, HDMI1 or HDMI2 buttons on your remote control to select the desired source (except being in teletext).

Note that in PIP/PAP modes, pressing  button will directly change sources.

Zoom Modes

Zoom mode can be changed by pressing the  button. You can change the screen size according to the picture aspect ratio. Select the optimum one from the following **ZOOM** modes.

Note:

- In YPBPR and HDMI modes, while in 720p-1080i resolutions, only FULL mode is available.
- In PC mode, only 4:3 and 16:9 modes are available.

Auto

When a **WSS (Wide Screen Signalling)** signal, which shows the aspect ratio of the picture, is included in the broadcast signal or the signal from an external device, the TV automatically changes the **ZOOM** mode according to the **WSS** signal.

- When the **AUTO** mode does not function correctly due to poor **WSS** signal quality or when you want to change the **ZOOM** mode, change to another **ZOOM** mode manually.

Zoom

This uniformly stretches the left and right sides of a normal picture (4:3 aspect ratio) to fill the wide TV screen.

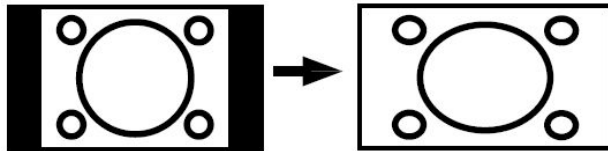

- For 16:9 aspect ratio pictures that have been squeezed into a normal picture (4:3 aspect ratio), use the **Full** mode to restore the picture to its original shape.

Cinema

This zooms up the wide picture (16:9 aspect ratio) to the full screen.

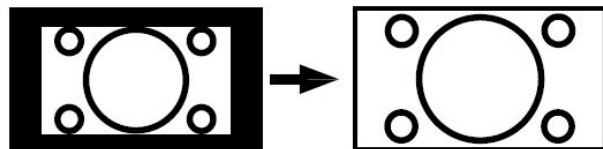

16:9 Zoom

This zooms up the wide picture (16:9 aspect ratio) to the full screen.

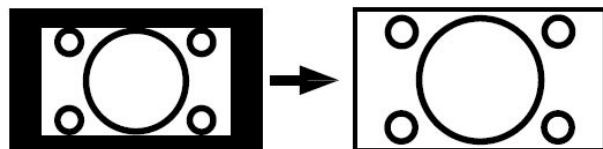

Subtitle

This zooms up the wide picture (16:9 aspect ratio) with subtitles to the full screen.

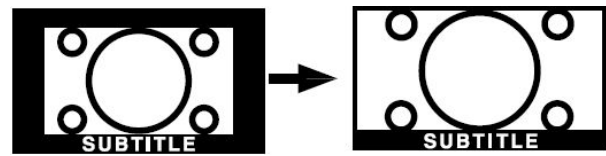

4:3

Use to view a normal picture (4:3 aspect ratio) as this is its original shape.

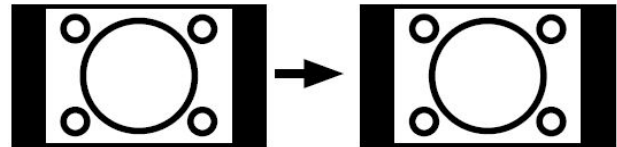

14:9 Zoom

This zooms up the wide picture (14:9 aspect ratio) to the upper and lower limits of the screen.

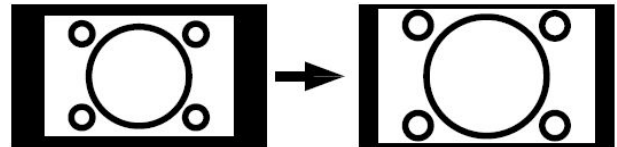

Panoramic

This stretches the left and right sides of a normal picture (4:3 aspect ratio) to fill the screen, without making the picture appear unnatural.

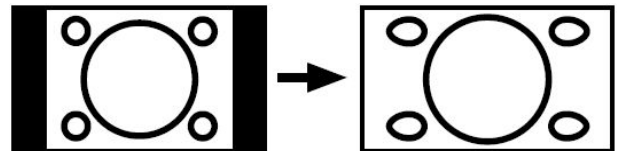

The top and bottom of the picture are slightly cut off.

Freeze Picture

You can freeze the picture on the screen by pressing the  button.

Note: This feature will be unavailable to be used while watching PC, YPBPr and HDMI sources.

Teletext

Teletext system transmits information such as news, sports and weather on your TV. Note that if the signal becomes insufficient, some text errors may occur or the teletext mode may be quitted. **Teletext function buttons** are listed below:

Teletext On/Off

Activates teletext mode when pressed once.

Teletext PAT mode

Pressing this button will split the screen into two windows, one displaying the teletext and the other displaying the current channel. Pressing again will switch to teletext mode in a single screen.

Index

Selects the teletext index page.

Reveal

Shows hidden information (solutions of games, for example).

Hold

Holds a text page when convenient. Press again to resume.

Subcode Pages / Time

Selects subcode pages if available when the teletext is activated. When the teletext is not activated, displays time info if the programme has teletext transmission.

P+ / P- and numbers (0-9)

Press to select a page.

Note: Most TV stations use code **100** for their index pages.

Coloured buttons (RED/GREEN/YELLOW/BLUE)

Your TV supports both **FASTEXT** and **TOP text** systems. When these systems are available, the pages are divided into groups or topics.

When **FASTEXT** system is available, sections in a teletext page will become colour-coded and can be selected by pressing the coloured buttons. Press a coloured button that corresponds with your needs.

The coloured writings will appear, showing you which coloured buttons to use when **TOP text** transmission is present. Pressing **P -** or **P +** commands will request the next or previous page respectively.

Connect Peripheral Equipment

High Definition

Your LCD Television is capable of displaying High Definition pictures from devices such as a High Definition Satellite Receiver or DVD Player. These devices must be connected via the HDMI socket or Component Socket. These sockets can accept either 720p or 1080i signals.

Note: When it is desired to watch HDMI source with a DVI to HDMI cable; in order to enable audio, Audio Input (which is located at the left side of the antenna input) is to be used to get DVI device's audio signals.

Via The Scart

The TV has 2 Scart sockets. If you want to connect peripherals (e.g. video, decoder, etc.) which have Scart sockets to the TV, you can use SCART socket of the TV.

Note: If an external device is connected via the Scart sockets, the TV will automatically switch to AV mode. If both sockets are employed at the same time, SCART 1 becomes the preferential.

Via Aerial Input

If the device you want to connect does not have a Scart socket, you should connect it to the Aerial input of the TV.

If the VCR is connected via Aerial input, it is suggested to use Programme 0.

Decoder

If you are subscribed to cable TV offers, the organisation will supply you a corresponding decoder unit to allow the programmes to be unscrambled.

For further information consult your dealer.

Connect a decoder with an aerial socket to the TV

- Connect the aerial cable.

Connect a decoder without an aerial socket to the TV

- Connect the decoder to the **EXTERNAL** socket of TV with a RCA cable. Through the **SCART/RCA** socket of the decoder, you may attain a better display resolution.

TV And Video Recorder

- Connect the aerial cables.

Better picture quality can be obtained if you also connect a Scart cable to **SCART** sockets.

Playback NTSC

- Connect NTSC VCR player to a SCART socket of the TV.
- Then, select the related source from the **SOURCE** menu. Source selection for **VCR** recording.
- Select **Feature** menu.
- Select **AV-2 Out** by pressing ▼ / ▲ button.
- For copying the picture that comes from the tuner, select SCART 1.

Note: Scart-1 socket cannot be used as DTV output. Please use Scart-2 instead.

Camera And Camcorder

To Connect To AV Input

Connect your camera or camcorder to AV input of the TV.

- Connect your equipment to the TV via **VIDEO** (yellow), **AUDIO R** (red) and **AUDIO L** (white) inputs. You must connect the jacks into the input with the same colour.

To Connect To S-VHS Input

Connect your camera or camcorder S-VHS input of the TV.

- Connect your equipment to the TV via S-VHS input and audio inputs of AV inputs by using S-VHS cables.

Connect The Decoder To The Video Recorder

Some video recorders have a special Scart socket for decoder.

- Connect a **SCART** cable to the **SCART** socket of your decoder and to the special Scart socket of your video recorder. Refer to the booklet of your video recorder.

Connecting Headphones (optional)

Use the stereo headphone socket of the TV, to connect headphones.

Note: If you want to connect more equipment to your TV, consult your dealer.

Audio Lineout

To connect the external speakers to your TV, use the Line Outs of the TV.

Note: While watching PC or YPbPr sources, Lineout selection could only be the current source.

Connecting Subwoofer

Use **Subwoofer Out** socket to connect an external, active subwoofer to the set to give a much deeper bass effect.

Tips

Care Of The Screen

Clean the screen with a slightly damp, soft cloth. Do not use abrasive solvents as they may damage the TV screen coating layer.

Poor Picture

Have you selected the correct TV system? Is your TV set or house aerial located too close to non-earthed audio equipment or neon lights, etc.?

Mountains or high buildings can cause double pictures or ghost images. Sometimes you can improve the picture quality by changing the direction of the aerial.

Is the picture or Teletext unrecognisable? Check if you have entered the correct frequency.

The picture quality may degrade when two peripherals are connected to the TV at the same time. In such a case, disconnect one of the peripherals.

No Picture

Is the aerial connected properly? Are the plugs connected tightly to the aerial socket? Is the aerial cable damaged? Are suitable plugs used to connect the aerial? If you are in doubt, consult your dealer.

No Picture means that your TV is not receiving a transmission. Have you selected the correct button on the remote control? Try once more.

Sound

You can not hear any sound. Did you perhaps interrupt the sound, pressing the  button?

Sound is coming from only one of the speakers. Is the balance set to one extreme? See **Sound** menu.

Remote Control

Your TV no longer responds to the remote control. Perhaps the batteries are exhausted. If so you can still use the local buttons at the bottom of the TV.

Peripheral Equipment Connections

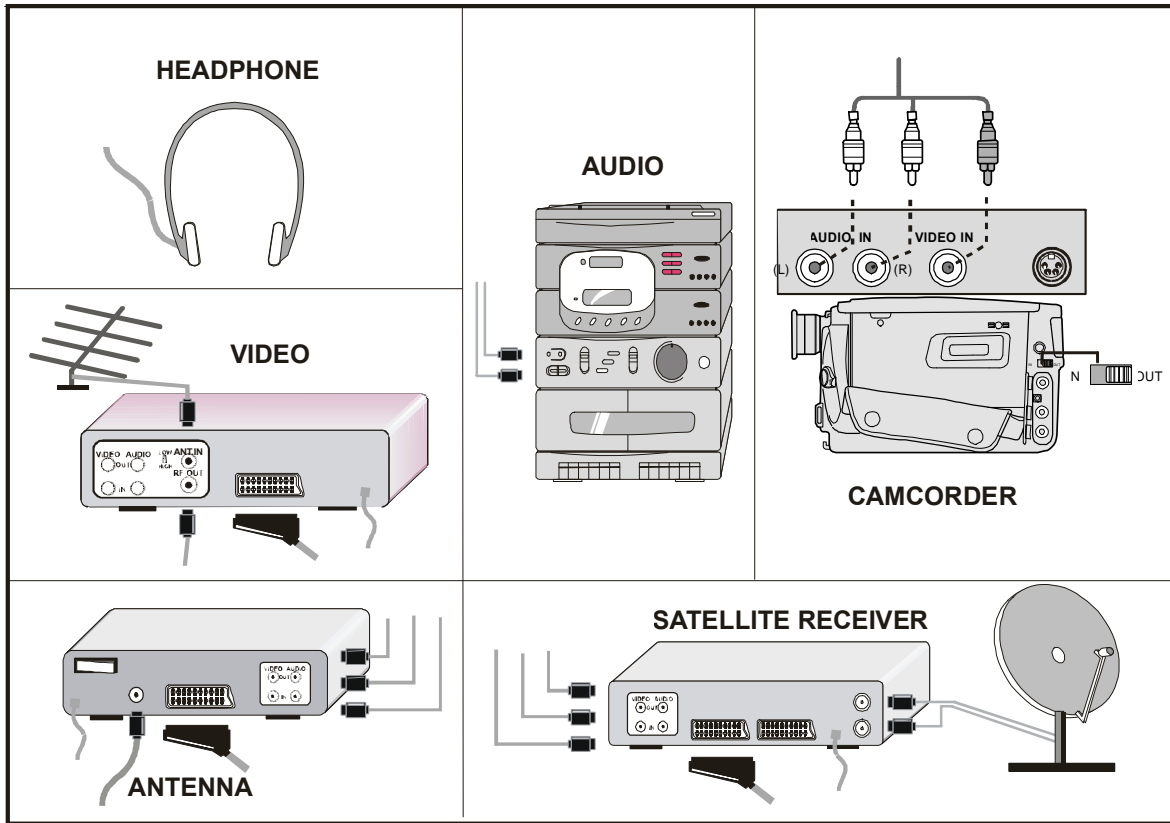

Aerial Connection

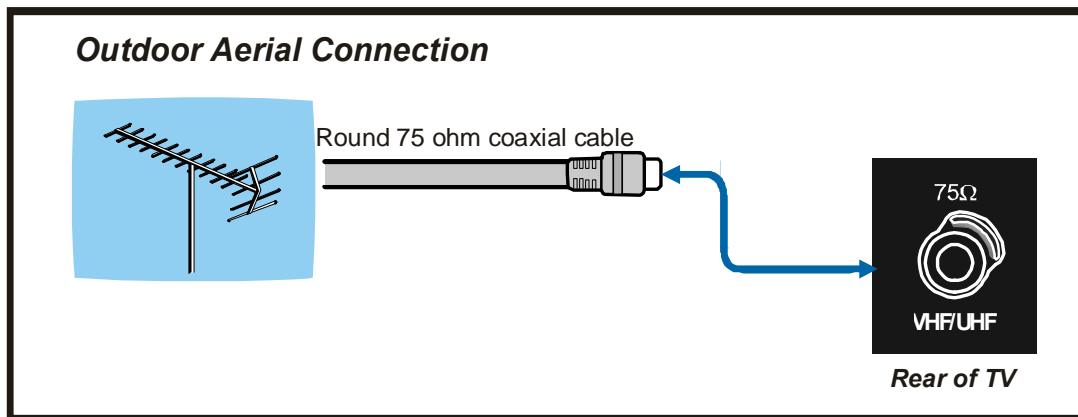

Specifications

DISPLAY

Size/Diagonal	32" (16:9 Display)
Viewable screen size/Diagonal	69.87 x 39.33 (cm) / 80.18 (cm)

VIDEO STANDARDS

Video PAL/NTSC/SECAM

TV Tuner (Analog) PAL/SECAMB/G D/K K' I' L/L'
VHF (BAND VIII)
UHF (BAND U)
HYPERBAND
CABLE TV (S1-S20 / S21-S41)
100 PRESET CHANNELS

TV Tuner (Digital) MHEG-5 ENGINE compliant with ISO/IEC 13522-5
Ukengine Profile 1
Object carousel support compliant with ISO/IEC 135818-6 and UK DTT profile
Frequency range: 474-850 MHz
Transmission standard: DVB-T. MPEG-2
Demodulation: COFDM with 2K/8K FFT mode
FEC: all DVB modes
Video: MP@ML, PAL, 4:3/16:9
Audio: MPEG Layer I&II 32/44.148kHz.

Formats 4:3, 16:9, 14:9, Panoramic, Default Zoom, Auto Wide

AUDIO German + Nicam Stereo

FREQUENCY RANGE PC

Horizontal Frequency: 64 Khz (max)
Vertical Frequency: 75 Hz (max)
Clock Frequency: 108 Mhz (max)
Resolutions: 1360 x 768 (max)
Formats: 4:3, 16:9

INPUT CONNECTIONS

PC D-SUB 15 (VGA)

VIDEO TV TUNER: IEC 75 Ohms input resistance
SCART1: CVBS, RGB
SCART2: CVBS, S
CVBS: 1 x RCA
Y/C (S-Video) MiniDIN
YPbPr: 3 x RCA
HDMI x 2: Multimedia Interface

AUDIO SCART1: Audio L/R
SCART2: Audio L/R
Y/C or CVBS: Audio Phono L/R
YPbPr: Audio Phono L/R
PC: 3.5mm Jack Stereo
Headphones: 3.5mm Jack Stereo

Specifications

OUTPUT CONNECTIONS

Line Out	Audio Phono L/R
Subwoofer	1 x Phono (Mono)
Audio Speaker Output	2x8 W RMS
Synchronization	Sync on green, composite sync with automatic detection separate H and V sync.

Operator Control Keys

On/Off, Standby, Vol+, Vol-, Prog +, Prog -, Menu, TV/AV.

OPERATING CONDITIONS

Temperature	0°C ~40°C (in operation)
Air Humidity	20%~80% (no condensation)
Atmospheric Pressure	800~1114 HPa

POWER SUPPLY

Voltage Supply	220-240V AC
Mains Frequency	50Hz
Power Consumption	155W (Max), <1 W (Standby)

DIMENSIONS AND WEIGHT

Display with stand D x L x H:	245 x 807 x 605 (mm)
Display without stand: D x L x H:	123 x 807 x 555 (mm)
Weight Display:	14.5 kg
Weight Stand:	2.5 kg
Weight (net):	17 kg

Specifications

Signal Input

PC RGB Terminal (D-sub 15-pin connector)

Pin	Input signal
1	R
2	G or sync on green
3	B
4	No connection
5	No connection
6	R.GND
7	G.GND
8	B.GND
9	No connection
10	GND
11	No connection
12	[SDA]
13	H.sync or H/V composite sync
14	V.sync. [V.CLK]
15	[SCL]

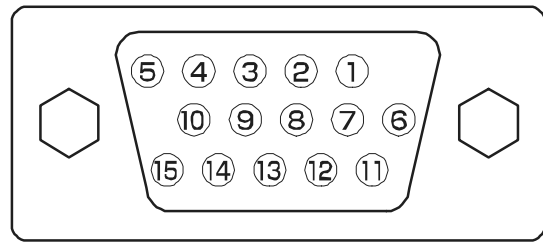

- When different kinds of input signals are simultaneously input to the monitor via a graphics board or the like, the monitor will automatically select the signals in the following priority order:

Sync signal type	Priority
H/V separate sync.	1
H/V composite sync.	2
sync.on Green *	3

- Even in the case of the recommended signals shown on the following page, there may be instances when correct display is not possible. In this case, use H/V separate sync, H/V composite sync.

S-input connector pin specifications

Pin	Input signal
1	Y
2	Y-GND
3	C
4	C-GND
Frame	GND

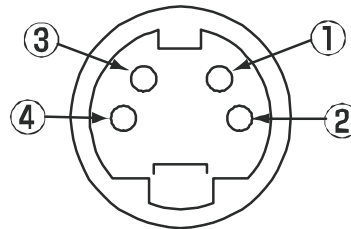

HDMI connector pin specifications

Pin	Input signal	Pin	Input signal
1	TMDS Data2+	11	TMDS Clock Shield
2	TMDS Data2 Shield	12	TMDS Clock-
3	TMDS Data 2-	13	CEC
4	TMDS Data 1+	14	Reserved (N.C. on device)
5	TMDS Data1 Shield	15	SCL
6	TMDS Data1-	16	SDA
7	TMDS Data0+	17	DDC/CED Ground
8	TMDS Data0 Shield	18	+5V Power
9	TMDS Data0-	19	Hot Plug Detect
10	TMDS Clock+		

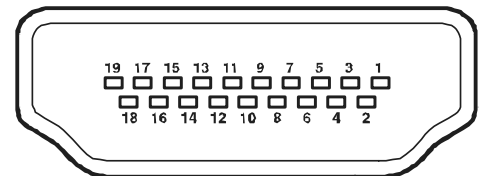

SCART connector pin specifications

Pin	Input signal	Pin	Input signal
1	AUDIO OUT (RIGHT)	12	Not used
2	AUDIO IN (RIGHT)	13	RGB-R GND
3	AUDIO OUT (LEFT/MONO)	14	GND
4	AUDIO GND	15	RGB-R / S.VHS CHROMINANCE IN
5	RGB-B GND	16	BLANKING SIGNAL
6	AUDIO IN (LEFT/MONO)	17	COMPOSITE VIDEO GND
7	RGB-B IN	18	BLANKING SIGNAL GND
8	AUDIO / RGB SWITCH / 16:9	19	COMPOSITE VIDEO OUT
9	RGB-G GND	20	COMPOSITE VIDEO / S.VHS LUMINANCE IN
10	Not used	21	GND / SHIELD (CHASSIS)
11	RGB-G IN		

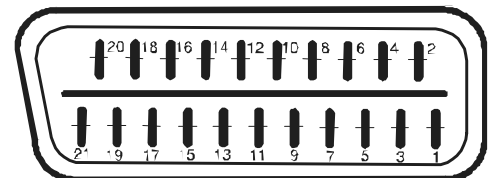

Appendix A: PC Input Typical Display Modes

The display has a maximum resolution of 1360 x 768, frequency range of 56-75 Hz.

The following table is an illustration of some of the typical video display modes.

Mode	Resolution		Frequency	
	Horizontal	Vertical	Hor.(kHz)	Ver.(Hz)
1	640	480	31,5	60
2	640	480	37,9	72
3	640	480	37,5	75
4	800	600	35,2	56
5	800	600	37,9	60
6	800	600	48,1	72
7	800	600	46,9	75
8	1024	768	48,4	60
9	1024	768	56,5	70
10	1024	768	60	75
11	1280	1024	64	60
12	1280	768	47,8	60
13	1360	768	47,7	60

Appendix B: AV and HDMI Signal Compatibility

Source	Supported Signals	Available	
AV-1 (SCART 1)	PAL 50/60	O	
	NTSC 60	O	
	RGB 50	O	
	RGB 60	O	
AV-2 (SCART-2)	PAL 50/60	O	
	NTSC 60	O	
	S-VHS 50	O	
	S-VHS 60	O	
AV-5 (YPbPr)	480I	60Hz	O
	480P	60Hz	O
	576I	50Hz	O
	576P	50Hz	O
	720P	50Hz	O
	720P	60Hz	O
	1080I	50Hz	O
	1080I	60Hz	O
AV-4 (FAV)	PAL 50/60	O	
	NTSC 60	O	
(S-Video)	PAL 50/60	O	
	NTSC 60	O	
HDMI1 HDMI2	480I	60Hz	O
	480P	60Hz	O
	576I	60Hz	O
	576P	60Hz	O
	720P	60Hz	O
	720P	50Hz	O
	1080I	50Hz	O
	1080I	50Hz	O
	1080P	50Hz	X
	1080P	60Hz	X
	1080P	24 HZ	X

(X: Not Available, O: Available)

Note: In some cases a signal on the LCD TV may not be displayed properly. The problem may be a inconsistency with standards from the source equipment (DVD, Set-top box, etc...). If you do experinece such a problem please contact your dealer and also the manufacturer of the source equipment.

Appendix C: Main and PIP-PAP Picture Combinations

Main and PIP, PAP picture combinations

MAIN → PIP,PAP ↓	TUNER	AV-1 CVBS	AV-1 RGB	AV-2 CVBS	AV-2 SVHS	AV-3 (*)	DTT	YPbPr (AV5)	FAV CVBS	S-VHS	HDMI	PC
TUNER	X	X	X	X	X	X	X	O	X	X	O	O
AV-1 CVBS	X	X	X	X	X	X	X	O	X	X	O	O
AV-1 RGB	X	X	X	X	X	X	X	O	X	X	O	O
AV-2 CVBS	X	X	X	X	X	X	X	O	X	X	O	O
AV-2 S-VHS	X	X	X	X	X	X	X	O	X	X	O	O
DTT	X	X	X	X	X	X	X	O	X	X	O	O
YPbPr (AV5)	O	O	O	O	O	O	O	X	O	O	X	X
FAV CVBS	X	X	X	X	X	X	X	O	X	X	O	O
SVHS	X	X	X	X	X	X	X	O	X	X	O	O
HDMI 1	O	O	O	O	O	O	O	X	O	O	X	X
HDMI 2	O	O	O	O	O	O	O	X	O	O	X	X
PC	O	O	O	O	O	O	O	X	O	O	X	X

(X: Not available, O : Available)

* Functional for the models having 3 SCART sockets.

Addendum to the instruction book.

The following is a key to the AV inputs:

Remote Control	Source Menu	Input Sockets on the set
TV/DTT	TV	Not applicable
TV/DTT	DTT	Not applicable
AV1	AV-1	AV1 (scart 1)
AV2	AV-2	AV2 (scart 2)
*	AV-2S	(not marked see note below)
AV3 (there is no AV3	-----	(there is no AV3 input on this set)
AV4	FAV	AV4
*	S-VIDEO	S-VHS
AV5	YPbPr (Component)	Y PB PR L R
HDMI1	HDMI-1	HDMI-1
HDMI2	HDMI-2	HDMI-2
(there is no PC button)	PC	PC INPUT

Inputs can be selected by either using the appropriate buttons on the remote control or by selecting an input on the source menu.

*For AV-2S, select from the menu.

NB. AV-2S can be used by the use of an S-VHS to scart converter plug (not supplied) or a device which has scart output with S-video can be connected

*For S-VIDEO press INPUT and AV-4 twice or select from the menu.

PC can only be selected using the source menu.

Your Guarantee of Excellence

Thank you for purchasing this Hitachi Television.

In the unlikely event that this product should develop a fault, we undertake to replace or repair any part of the product which fails due to a manufacturing defect within 12 months of the date of purchase provided that:

- i) The product has been installed and used only in accordance with the instructions supplied with the product
- ii) The product has not been repaired, maintained, or modified by any person other than an Hitachi authorised engineer
- iii) The product serial number has not been removed or altered

This guarantee does not apply to product acquired second hand or for commercial or communal use

This guarantee does not cover the replacement of exhausted batteries, the adjustment of user controls, or aerial alignment.

Any parts replaced under this guarantee shall become the property of Hitachi Europe Ltd.

Please note that evidence of the date of purchase will be required before any service under this guarantee is carried out.

THIS GUARANTEE DOES NOT AFFECT YOUR STATUTORY RIGHTS.

IN ALL CASES OF DIFFICULTY PLEASE CONSULT YOUR HITACHI DEALER

IMPORTANT - If placing TV into cabinet or alcove, ensure there is at least a 100mm (10cm) gap to the sides, rear and top of the TV. This is to allow for adequate ventilation during operation. Please read the main Users Guide for more safety information before installation.

1

insert the batteries into your handset

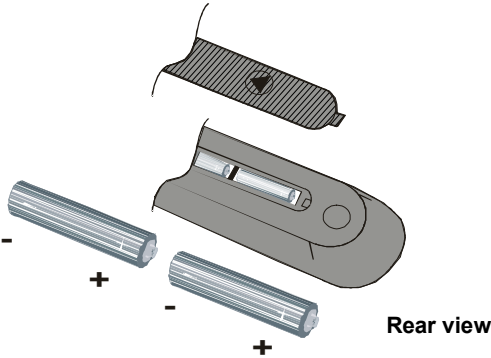

2a

either connect the aerial straight to your TV...

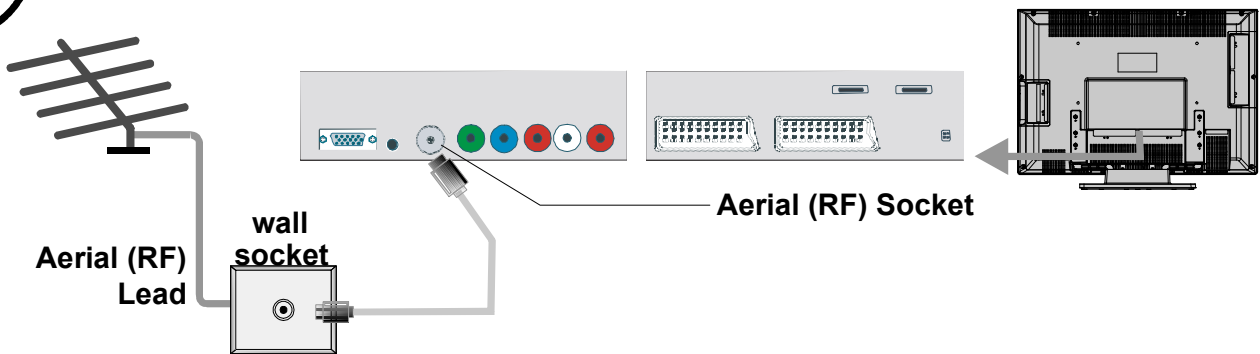

2b

...or connect the aerial through a VCR...

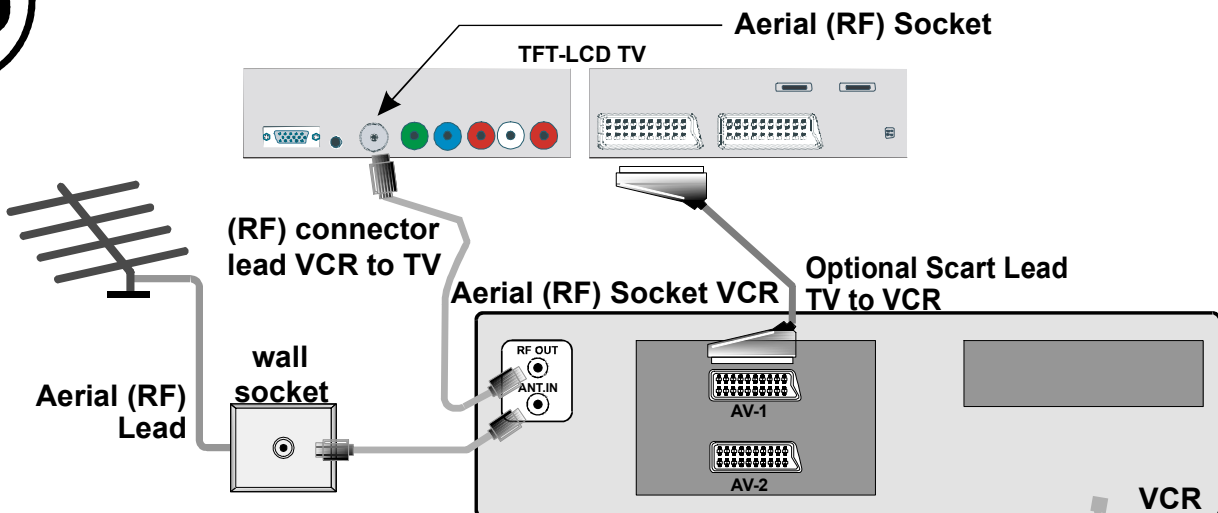

• It is recommended that a scart lead should be fitted between your TV and VCR to enhance your picture and sound quality. Scart leads are essential if you have a stereo TV and VCR and wish to obtain stereo sound from your equipment. These leads can be purchased from your Hitachi dealer or any good High Street electrical retailer.

2c

...or through a satellite decoder...

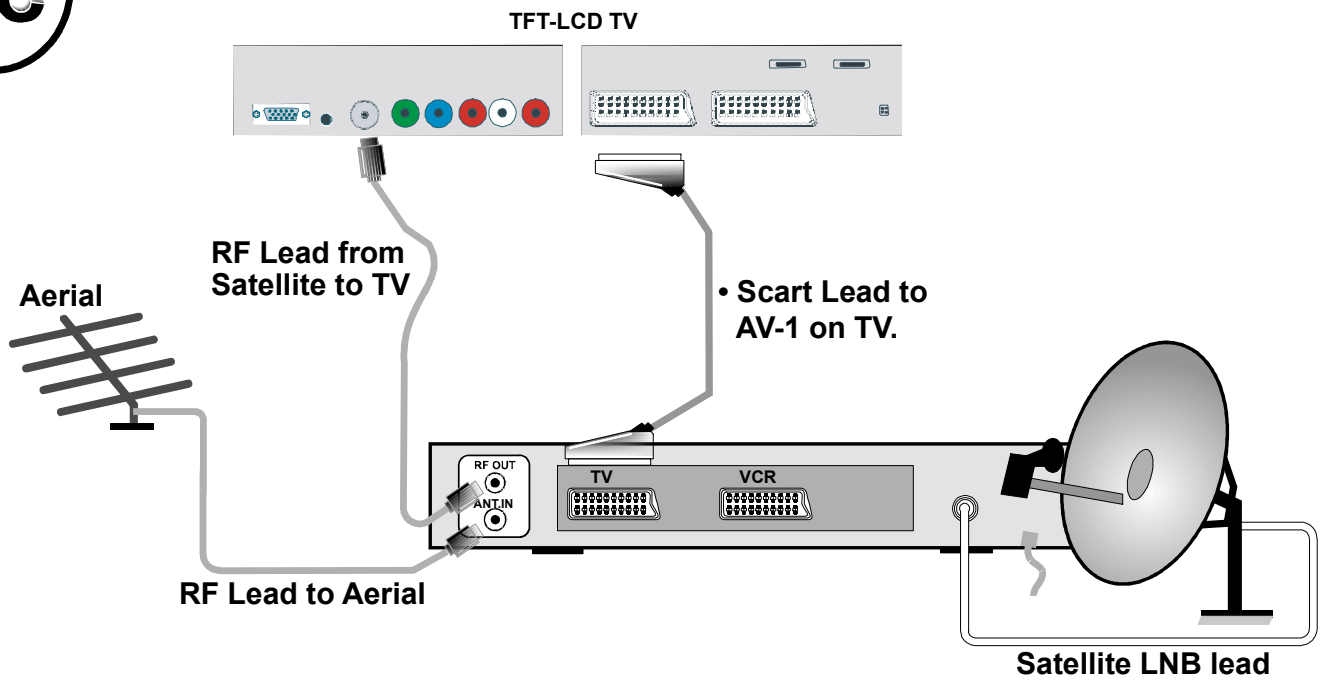

2d

...or through a VCR and satellite decoder.

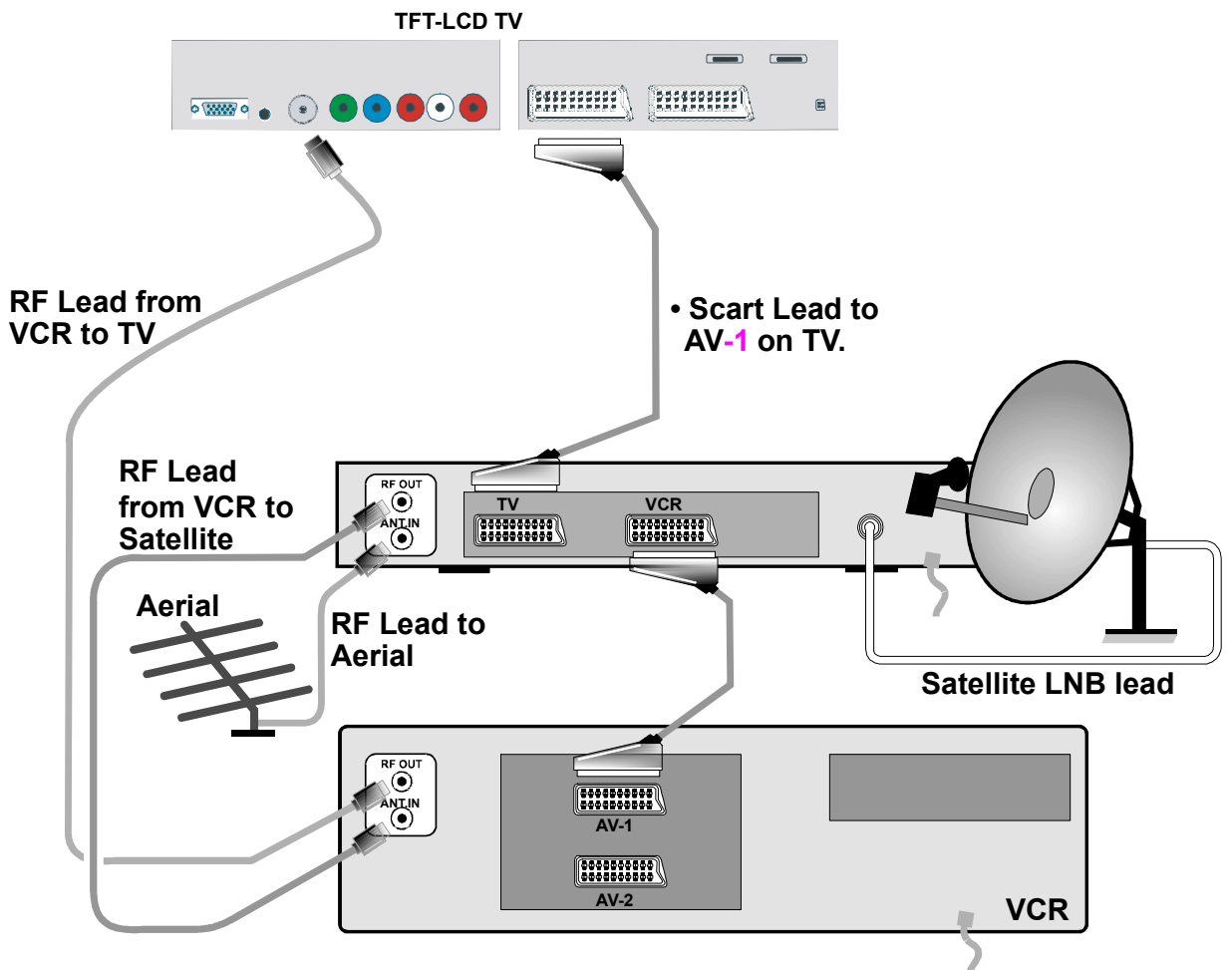

3

connect the TV plug to the mains socket

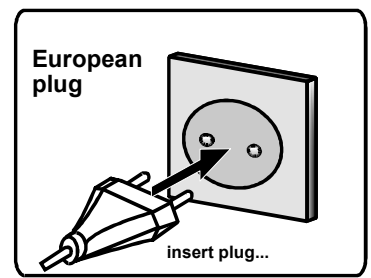
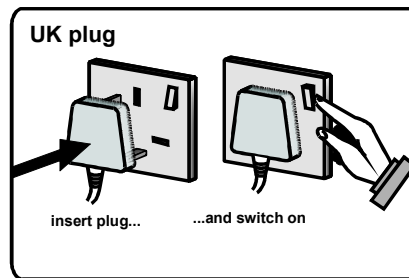
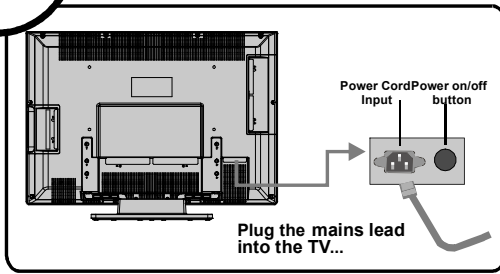

4

switch your TV on by pressing the On/Off button

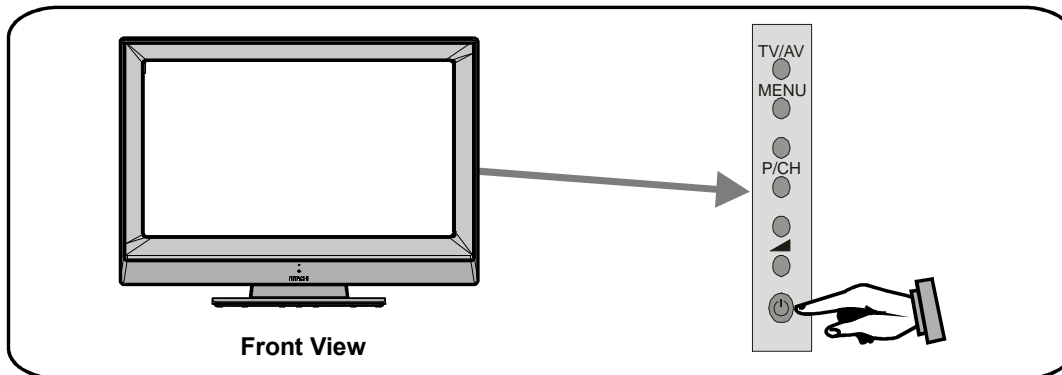

NB: When the set is first switched on, the set will be in standby and the indicator on the front of the set will illuminate red. Press the channel up down (P-, P+) or numeric buttons (1, 2, 3, ...) to operate.

basic functions of remote control

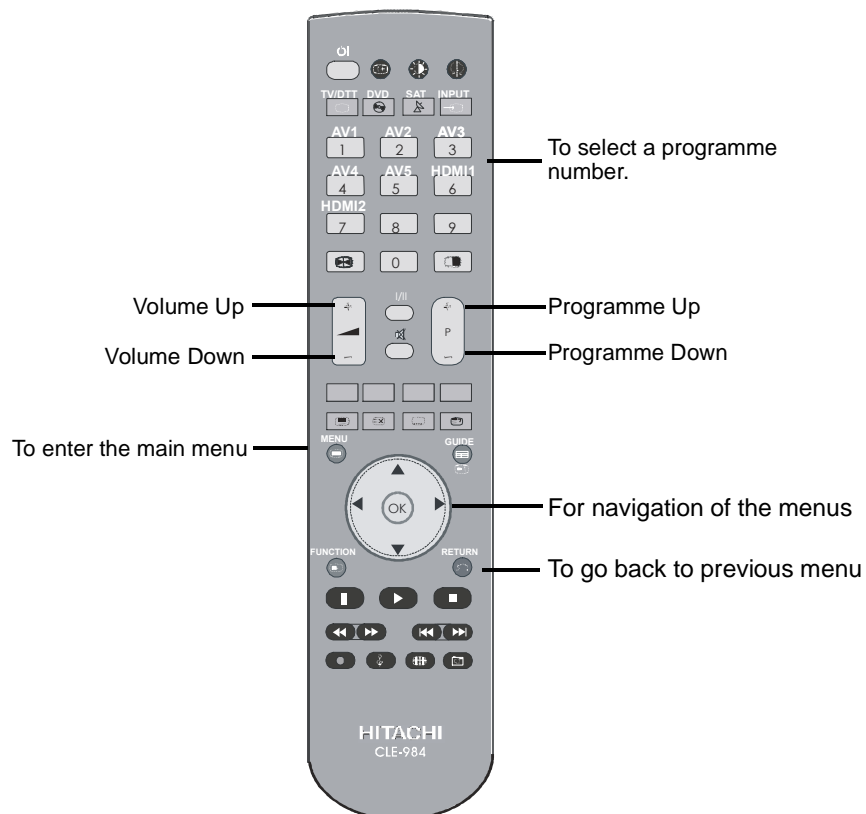

important note before starting Auto Setup

If you have a Video Cassette Recorder or a Satellite receiver connected to your TV please ensure that they are switched on before automatic tuning begins. In the case of a VCR, insert a pre-recorded tape and begin playback of your equipment. These measures ensure that all your external equipment is tuned in during the Auto Setup procedure.

5

start A.P.S. (Auto Programming System)

1

When the TV is turned on for the first time, the menu for the language selection appears on the screen. The message **“Welcome please select your language!”** is written in all language options sequentially in the menu on the screen. By pressing **▲** or **▼** buttons highlight the language you want to set and press **OK**. After then, **First time Installation Menu** will appear on screen. By pressing **◀** or **▶** buttons, select country item you want to set and press **OK** button.

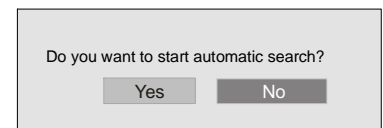
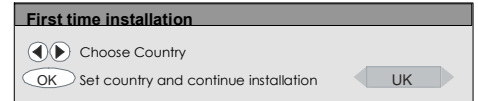

2

After the First Time Installation is set, the following message appears on the screen.

To start automatic search, select **“Yes”**, to cancel select **“No”**. This process will take about five minutes. To cancel searching, you can press **■** button at any time during the process.

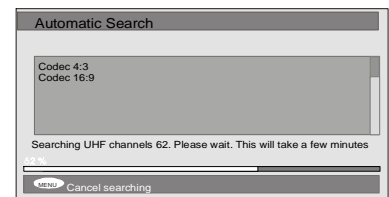

3

After **Automatic Search** process is completed, a message asking for analogue channel search appears on the screen. To continue Auto Program, first set the language, country and teletext language by using **◀** / **▶** button and then press the **RED** or **OK** button

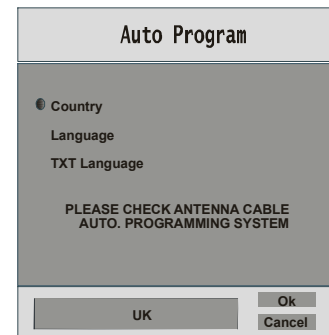

4

After APS is finalized, the programme table will appear on the screen. In the programme list you will see the programme numbers and names assigned to the programmes.

5

For details, please refer to the **Install Menu** section of the instruction book.

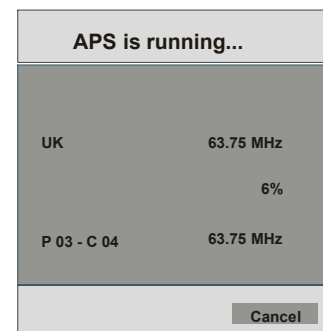

important note.

Once the TV has found all your local stations, they are then automatically assigned a programme number and name, if available from the broadcast.

HITACHI

Inspire the Next

Hitachi, Ltd.
Consumer Business Group
Shin-Otemachi Bldg 5f, 2-1, Otemachi 2-Chome,
Chiyoda-Ku, Tokyo 100-0004 Japan

HITACHI EUROPE LTD.

Consumer Affairs Department
PO Box 3007
Maidenhead
Berkshire SL6 8ZE

UNITED KINGDOM

Tel: 0870 405 4405
Email: consumer.mail@hitachi-eu.com

HITACHI EUROPE S.A.

364, Kifissias Ave. & 1, Delfon Str.
152 33 Chalandri
Athens

GREECE

Tel: 210 6837200
Fax: 210 6835694
Email: dmgservice.gr@hitachi-eu.com

HITACHI EUROPE GmbH

Munich Office
Dornacher Strasse 3
D-85622 Feldkirchen bei München

GERMANY

Tel: 089-991 80-0
Fax: 089 - 991 80 -224
Hotline: 0180 - 551 25 51 (12ct/min.)
Email: dmg-mun.service@hitachi-eu.com

HITACHI EUROPE S.A.

Gran Via Carles III, 86 Planta 5ª
Edificios Trade - Torre Este
08028 Barcelona

SPAIN

Tel: 93 409 2550
Fax: 93 491 3513
Email: atencion.cliente@hitachi-eu.com

HITACHI EUROPE S.r.l.

Via T. Gulli n.39
20147 MILAN

ITALY

Servizio Clienti
Tel. 02 38073415
Email: customerservice.italy@hitachi-eu.com

HITACHI EUROPE AB

Box 77
S-164 94 KISTA

SWEDEN

Tel: 08 562 711 00
Fax: 08 562 711 11
Email: csgswe@hitachi-eu.com

HITACHI EUROPE S.A.S

Digital Media Group
Cité Internationale
94 Quai Charles de Gaulle,
69463 LYON cedex 06

FRANCE

Tel: 04 72 14 29 70
Fax: 04 72 14 29 99
Email: france.consommateur@hitachi-eu.com

HITACHI EUROPE AB

(Norway Branch Nuf)
Strandveien 18
1366 Lysaker

NORWAY

Tel: 67519030
Fax: 67519032
Email: csgnor@hitachi-eu.com

HITACHI EUROPE LTD.

Benelux Branche Office
Bergensesteenweg 421
1600 Sint-Pieters-Leeuw

BELGIUM

Tel : 0032/2 363 99 01
Fax: 0032/2 363 99 00
Email : info@hitachi.be

HITACHI EUROPE AB

Egebækvej 98
2850 Nærum

DENMARK

Tel: 43 43 60 50
Fax: 43 43 60 51
Email: csgden@hitachi-eu.com

HITACHI EUROPE LTD.

Kodanska 46
101 00 Praha 10

CZECH REPUBLIC

Tel : 234 064 514
Fax: 234 064 513
Email : dmg.eeu@hitachi-eu.com

HITACHI EUROPE AB

Lars Sonckin kaari 16
FIN-02600 ESPOO

FINLAND

Tel: 010-8503085
Fax: 010-8503086
Email: info.finland@hitachi-eu.com



5011197