

N-Channel MOSFET

2SK2926-ZJ

■ Features

- V_{DS} (V) = 60V
- I_D = 15 A (V_{GS} = 10V)
- $R_{DS(ON)}$ < 55m Ω (V_{GS} = 10V)
- $R_{DS(ON)}$ < 110m Ω (V_{GS} = 4V)
- High speed switching

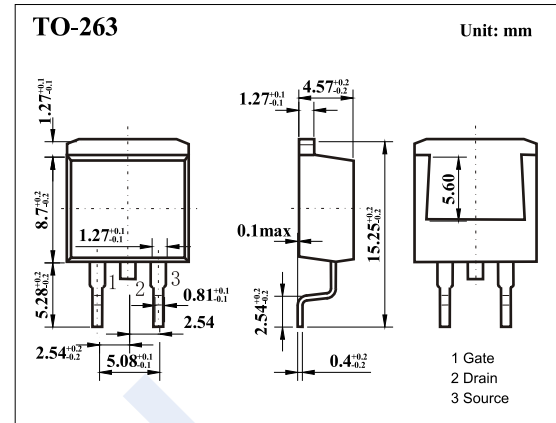
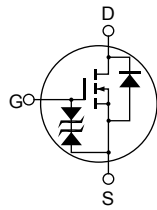

■ Absolute Maximum Ratings $T_a = 25^\circ\text{C}$

Parameter	Symbol	Rating	Unit
Drain-Source Voltage	V_{DS}	60	V
Gate-Source Voltage	V_{GS}	± 20	
Continuous Drain Current	I_D	15	A
Pulsed Drain Current (Note.1)	I_{DM}	60	
Body to Drain Diode Reverse Drain Current	I_{DR}	15	
Avalanche Current (Note.2)	I_{AR}	15	
Power Dissipation (Note.3)	P_D	25	W
Avalanche Energy (Note.2)	E_{AR}	19	mJ
Junction Temperature	T_J	150	$^\circ\text{C}$
Storage Temperature Range	T_{stg}	-55 to 150	

Note.1: $PW \leq 10\mu\text{s}$, duty cycle $\leq 1\%$

Note.2: Value at $T_{ch} = 25^\circ\text{C}$, $R_g \geq 50\ \Omega$

Note.3: Value at $T_c = 25^\circ\text{C}$

N-Channel MOSFET

2SK2926-ZJ

■ Electrical Characteristics $T_a = 25^\circ\text{C}$

Parameter	Symbol	Test Conditions	Min	Typ	Max	Unit
Drain-Source Breakdown Voltage	V_{DS}	$I_D=10\text{mA}$, $V_{GS}=0\text{V}$	60			V
Gate-Source Breakdown Voltage	V_{GS}	$I_D=\pm 100\mu\text{A}$, $V_{DS}=0\text{V}$	± 20			V
Zero Gate Voltage Drain Current	I_{DSS}	$V_{DS}=60\text{V}$, $V_{GS}=0\text{V}$			10	μA
Gate-Body Leakage Current	I_{GSS}	$V_{DS}=0\text{V}$, $V_{GS}=\pm 16\text{V}$			± 10	μA
Gate to Source Cutoff Voltage	$V_{GS(off)}$	$V_{DS}=10\text{V}$, $I_D=1\text{mA}$	1.5		2.5	V
Static Drain-Source On-Resistance	$R_{DS(on)}$	$V_{GS}=10\text{V}$, $I_D=8\text{A}$			55	$\text{m}\Omega$
		$V_{GS}=4\text{V}$, $I_D=8\text{A}$			110	$\text{m}\Omega$
Forward Transconductance	g_{FS}	$V_{DS}=10\text{V}$, $I_D=8\text{A}$	7	11		S
Input Capacitance	C_{iss}	$V_{GS}=0\text{V}$, $V_{DS}=10\text{V}$, $f=1\text{MHz}$		500		pF
Output Capacitance	C_{oss}			260		
Reverse Transfer Capacitance	C_{rss}			110		
Turn-On Delay Time	$t_{d(on)}$			10		
Turn-On Rise Time	t_r	$V_{GS}=10\text{V}$, $I_D=8\text{A}$, $R_L=3.75\Omega$		80		
Turn-Off Delay Time	$t_{d(off)}$			100		
Turn-Off Fall Time	t_f			110		
Body Diode Reverse Recovery Time	t_{rr}		$I_F=15\text{A}$, $V_{GS}=0$, $di/dt=50\text{A}/\mu\text{s}$		55	
Diode Forward Voltage	V_{SD}		$I_F=15\text{A}$, $V_{GS}=0\text{V}$		1	

■ Typical Characteristics

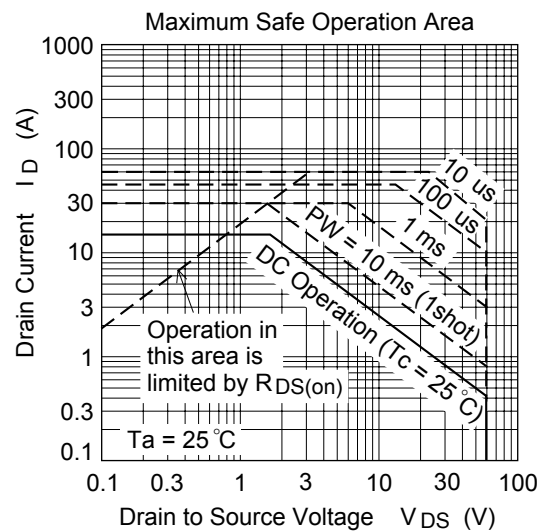
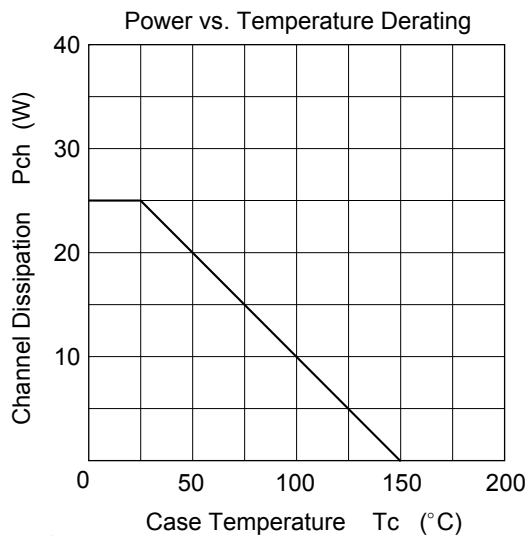

N-Channel MOSFET 2SK2926-ZJ

■ Typical Characteristics

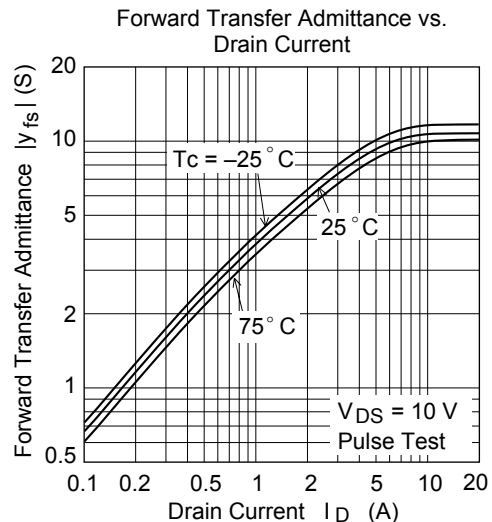
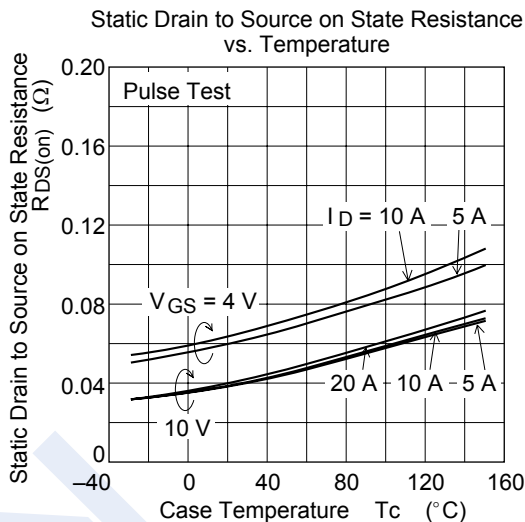
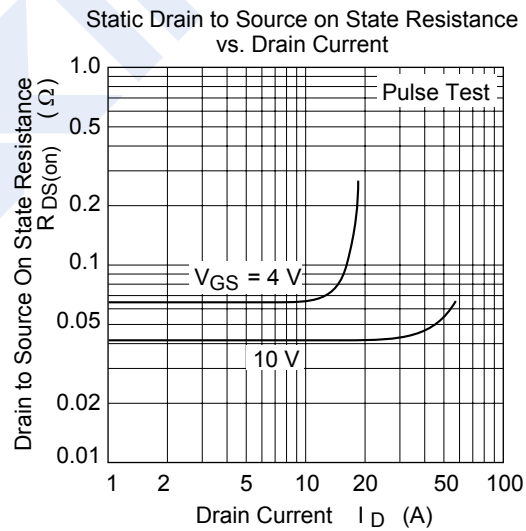
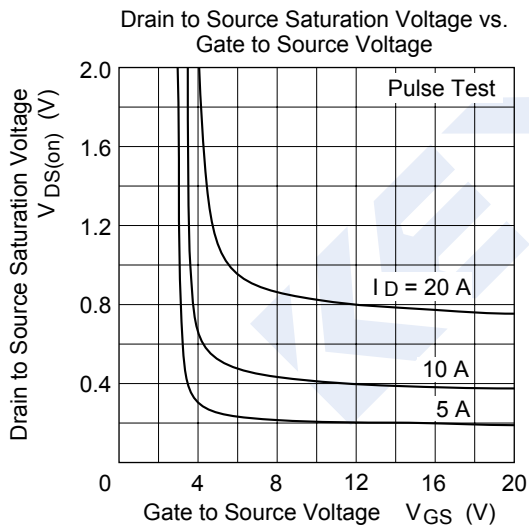
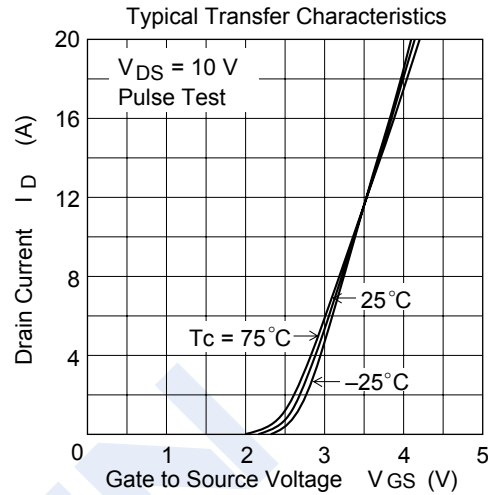
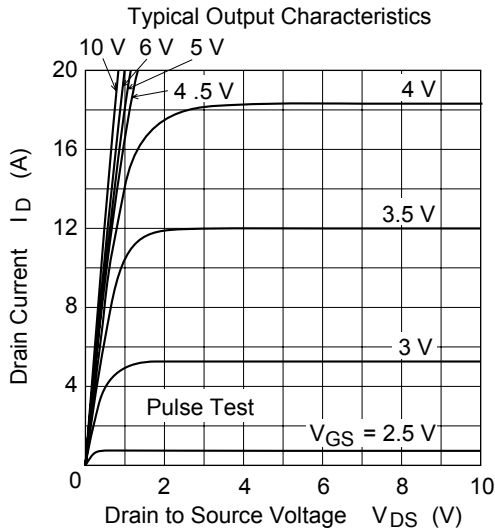

N-Channel MOSFET

2SK2926-ZJ

■ Typical Characteristics

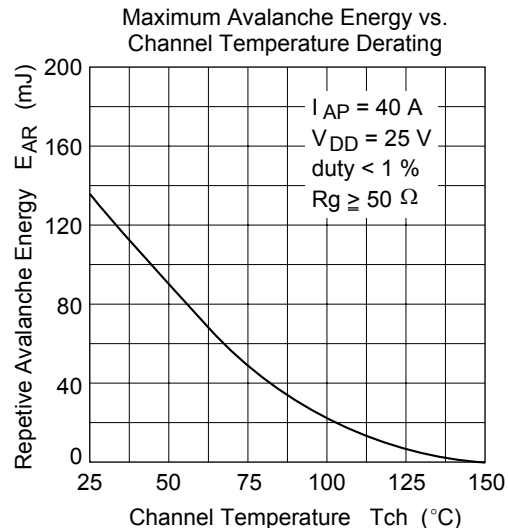
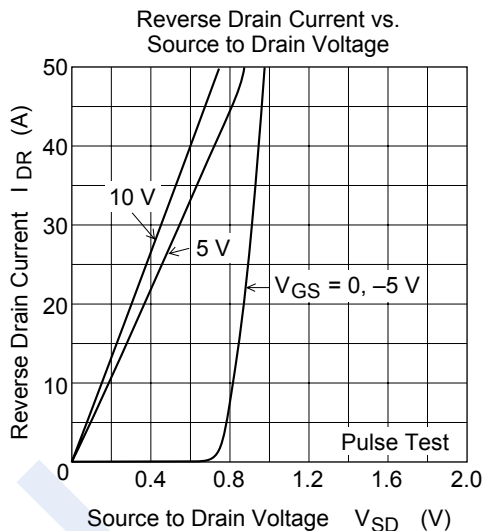
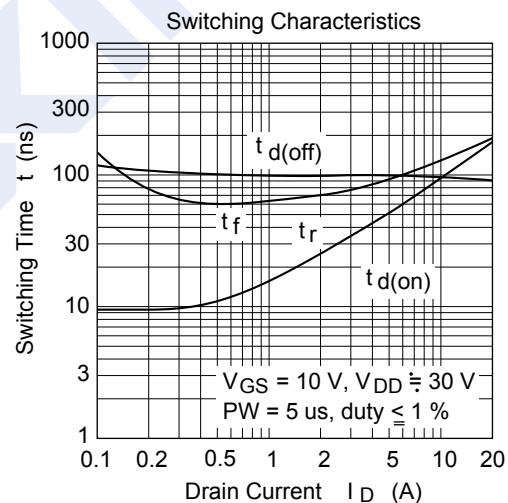
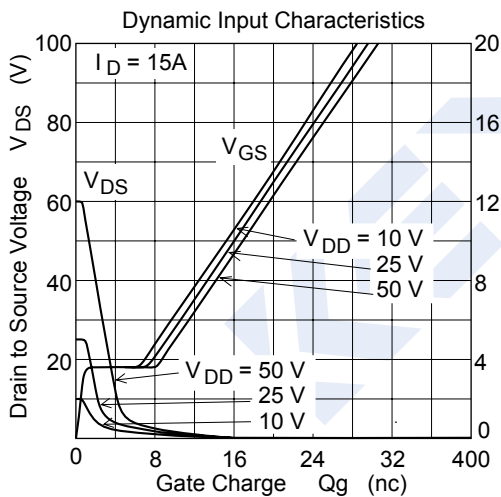
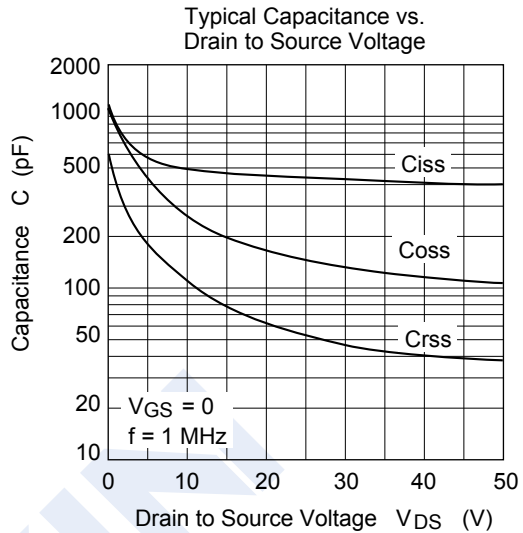
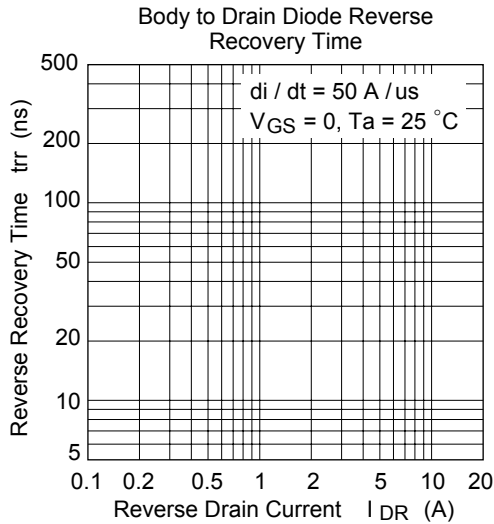

N-Channel MOSFET 2SK2926-ZJ

■ Typical Characteristics

Avalanche Test Circuit

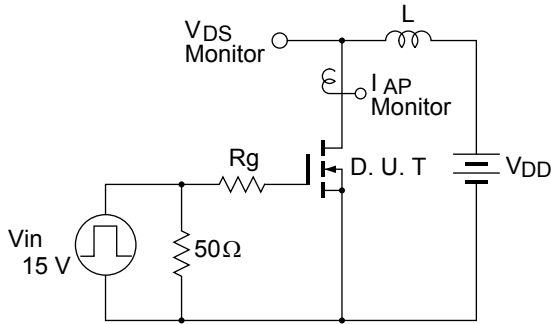

Avalanche Waveform

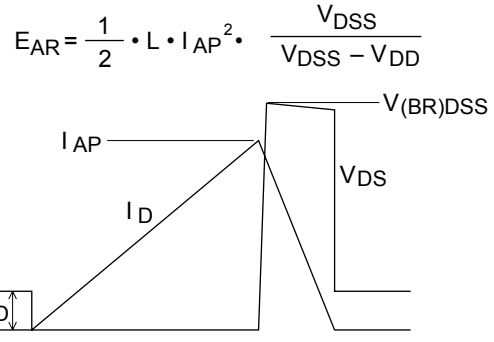

Normalized Transient Thermal Impedance vs. Pulse Width

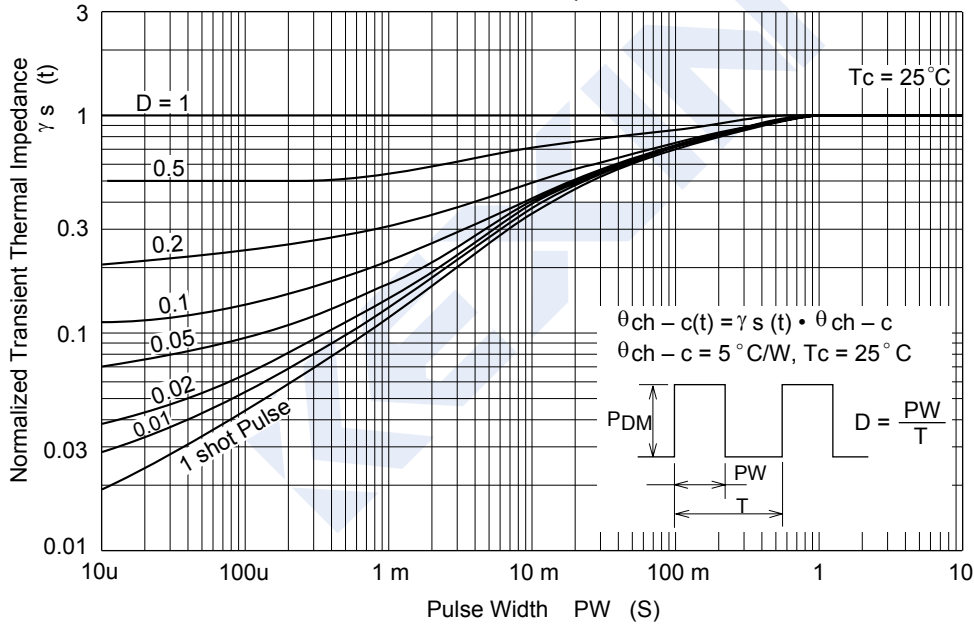

Switching Time Test Circuit

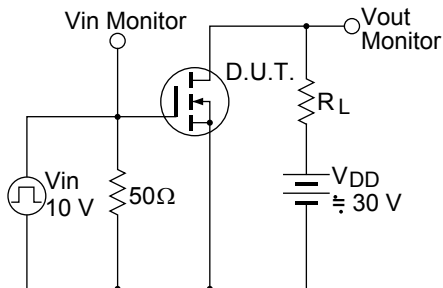

Switching Time Waveform

